

EUROLIFT BH[®]

Product Distributed in Ireland by:



601, Western Industrial Estate,
Dublin 12, Ireland

T: + 353 (0)1 4584836
E: sales@prolift.ie

www.prolift.ie

www.verlinde.com

Electric belt hoist for
load from 500 up to 5,000 kg

 **VERLINDE[®]**

LIFTING EQUIPMENT

Ref: JV 06 2013 35 UGB

The leading French manufacturer of lifting equipment

VERLINDE is the leading French manufacturer of hoisting equipment, capable of mass producing belt, cable and chain hoists, winches, jib cranes and bridge crane components, at its VERNOUILLET plant. From CAD/CAM design to execution, manufactured with amongst the most up-to-date machining facilities in any plant in Europe and backed by the skill and know-how of our experienced personnel, each hoist bearing the VERLINDE logo is a warrant for the user of both reliability and quality.

New products, news concepts

Attuned to the needs of its customers, VERLINDE has designed this belt hoist for customised applications in a wide variety of sectors such as the food industry, chemicals, the precision industries and, indeed, any environment where hygiene and safety are of utmost importance to quality production. VERLINDE has always been amongst the first to introduce new ideas in operation of hook hoisting units. The EUROLIFT BH electric belts hoist has been designed with this resolutely innovative attitude, as witnessed by the fact that its design alone has given rise to 3 patents. The EUROLIFT BH is today the only belt and hook hoisting unit offering you the following features in its standard version:

- > **Hoisting belt:** high strength belt with high safety factors, easy and quick to replace, thanks to its design.
- > **Two mechanically variable** hoisting speeds.
- > **Belt guide:** enhanced safety features against side pulling and twisting effects during lifting movement.
- > **Hoisting and control features complying** with IEC 34.1/IEC 34.2, IP 55 protection and class insulation standard.
- > Totally enclosed, high precision, silent and sealed **reduction gear.**
- > Adjustable upper and lower **limit switches.**
- > Travelling **limit switches.**
- > **Load limiter,** safety feature protecting against excessive overloading of the pulley and runway path (mandatory, to comply with the "MACHINES" Directive).
- > Very low "C" dimensions and hook "approaches".
- > **True vertical lift** (vertical movement of hook block when hoisting).

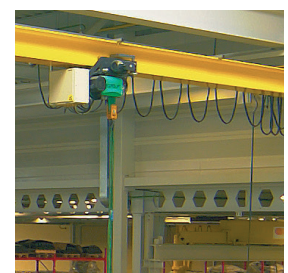
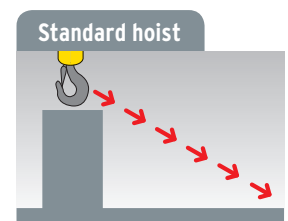
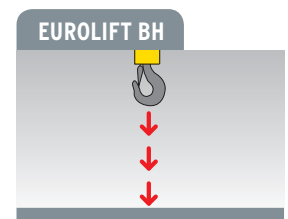

Customised installations

> Fixed version.

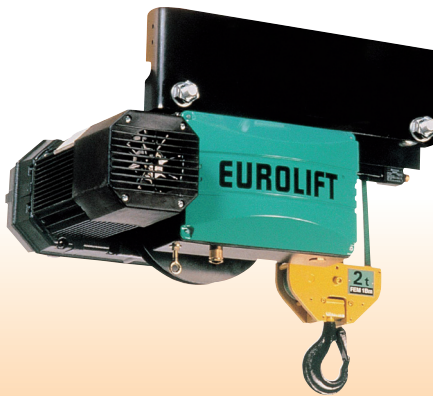

These hoists do not have a trolley and are designed for applications where no horizontal travel is needed.
Maximum capacity: 5,000 kg.

> Monorail short headroom powered travel trolley (HPR).



These hoists feature a trolley (for moving the load in the horizontal direction) with a design enabling the user to make optimum use of the headroom and working area available for your job.
Maximum capacity: 2,000 kg.

> Monorail short headroom hand-push travel trolley (HPR).



These hoists feature a trolley (for horizontal movement of the load) with a design enabling loads of up to 5,000 kg to be moved with optimised hoisting height.

> Monorail trolley into EUROSYSTEM profile.



These hoists feature a travelling trolley (for horizontal movement of the load). They are capable of lifting a load of up to 2,000 kg and moving it horizontally in a straight or curved EUROSYSTEM profile.

> Monorail powered boggy trolley for curved beams.

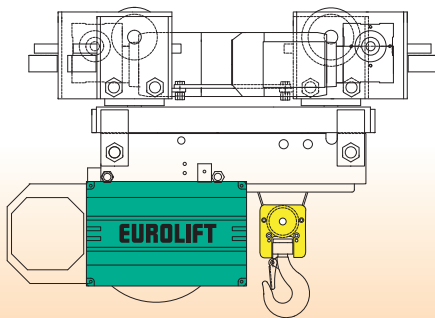

These hoists feature a trolley (for horizontal movement of the load) with a design enabling loads of up to 2,000 kg to be moved horizontally on curved beams.

> EUROLIFT BH "Stainless steel" version.

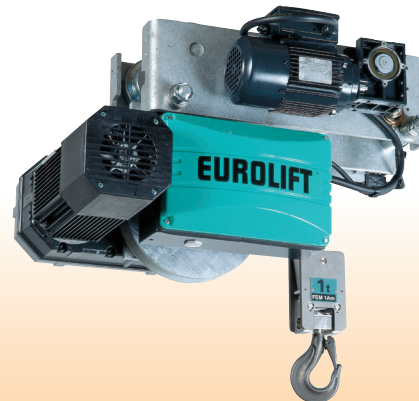

Lifting of loads of up to 2,000 kg with horizontal travel in an environment with high level of relative humidity.



EUROLIFT BH[®]

Electric belt hoist
for load from 500
up to 5,000 kg



Gear box
3 steps helical gear, life-lubricated (semi-fluid grease), comprising O-ring seals and lip seal at shaft end (BH2).

Lifting motor
2-speed motor, electromagnetic brake featuring automatic wear compensation. IP 55 protection. Class F insulation.



Overload limiter
The hoist has a load limiter as standard equipment, preventing hoisting in the event of overloads (in compliance with the European "MACHINES" Directive).

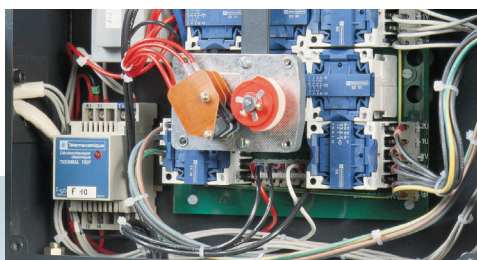
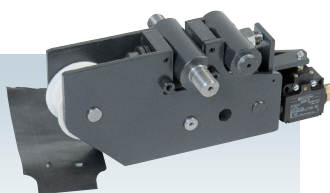

Electric cubicle
> 48V low voltage control.
> Printed circuit for standard voltage.
> NFE 52070 standard.
> Upper and lower limit switches.
> Hoisting motor protected by thermal sensors.
> IP 65-protected low voltage control push button box.

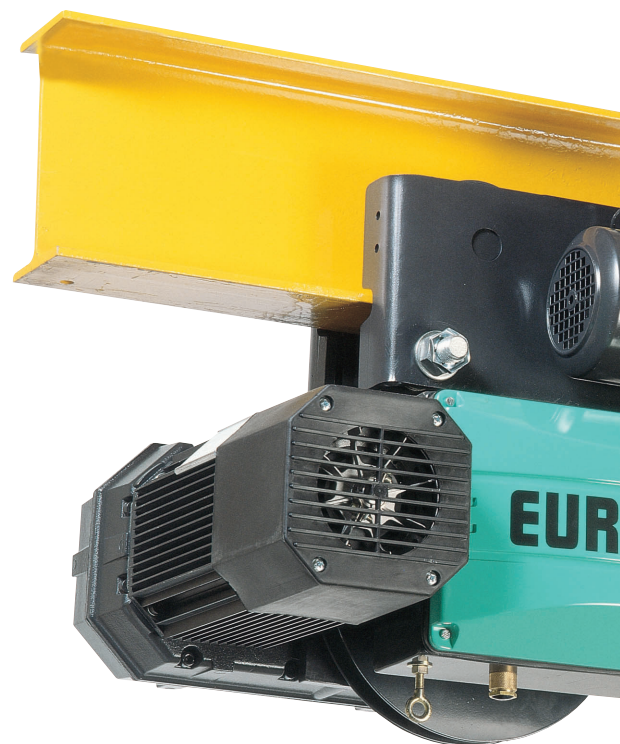

+ savings

Lifting motor. High operating factor ensuring longer service life.

Hook block. Small "C" dimensions and hook "approaches", enabling you to design your building to optimum size and make maximum use of the available working space.

Travel. Travelling motor with IP 55 protection and type F insulation, ensuring maximum service life.

+ technology

Lifting motor. Improved cooling of the motor, thanks to its mounting position outside the hoisting unit.

Motor, trolley gear box. Lifetime-lubricated travel gear box.

Hoisting brake. The brake features automatic compensation of wear and is tested for the service life of the hoist working under normal operating conditions.

Belt guide. "Springless" construction principle, making for easier replacement during maintenance operations.

Electrical cubicle. Mounted on the front face (BH2) or rear face (BH5) of the hoist, featuring ready access and openable by a snap-action system.

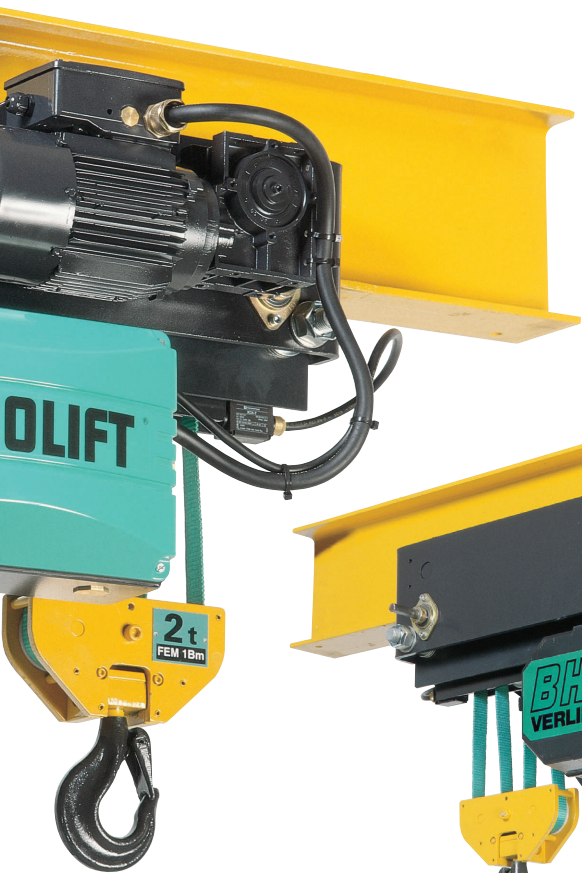

Lifting belt

Flame-retardant with good dimensional stability and excellent ability to maintain its strength after immersion in boiling water. Excellent ability to withstand attack by acids. Immune to attack by solvents. Rot-proof.

BH5: Dynema belt (this belt has the same characteristics as those of the BH2, with a greater safety factor).



Hook block

Possibility of stainless steel hook block and hook.



+ ergonomics

Push button box. With in-depth colored polypropylene with double insulation and ergonomic design (IP 65 protection).

+ safety

Travelling. 2 traveling speeds (20/5 m/min. 10 2,5 m/min and BH2) for more accurate positioning of your loads.

Belt. Excellent ability to withstand attack by acids, immune to solvents, rot-proof and fire retardant.

Electrical cubicle. 48 V control. The cover is equipped with two anti-drop type steel safety cables (BH2) or hinges (BH5).

Belt guide. High safety feature against side pulling and twisting effects during hoisting movement.

Stainless steel version of electric belt hoist for loads from 500 up to 5,000 kg

> **Power travelling trolley.** Wheels, axes and diverter sheaves undergo anti-corrosion treatment to improve protection against external sources of aggression. The side plates of the trolley and spreader and the plates of the structure are hot dipped galvanised.

The side plates of the drum and the drum support are hot dipped galvanised.

> **Hook block,** Hook, lower cross head and bearing are in stainless steel, for applications in environments with a high level of relative humidity.

> **Gear box,** The gear box mounting is hot dipped galvanised for anti-corrosion protection.



EUROLIFT BH®

Options available

The EUROLIFT BH can be equipped with a great many options and can be specifically adapted for special purpose uses:

- > Non standard beam section width.
- > Higher travelling speeds.
- > Time counter.
- > EUROMOTE type infrared or radio remote-control.
- > Travelling movement limit switch.
- > Tropicalised travelling movement and lifting motors.
- > Trolley mounted on bogies.
- > Special power supply voltage.
- > Load limiter with 2 or 3 steps.
- > Total anti-corrosion protection*.
- > Stainless steel hook and hook block**.
- > Covering roof for protection against rain.
- > Horn controlled from push button box.
- > Explosion-proof hoist.

*Except BH5.

**Up to 2.5 T only. 3.2 T and 5 T stainless steel hook block, painted hook.



Standards and hoisting regulations



Compliance with EC Directive. Since 1st January 1995, the "EC" standard on machines 98/37/EEC, requires manufacturers of machines to harmonise their production to comply with certain provisions, standards, national rules of practice and technical specifications. Each VERLINDE unit bears the "EC" label and is delivered with an "EC" certificate of conformity (appendix IIA) or has a built-in certificate (appendix IIB).

F.E.M. The European Handling Equipment Federation.

S.W.P. Safe Working Period. The "Safe Working Period" of the hoisting unit is determined in terms of average type of use of the hoisting mechanism, load range and utilisation group. After this period has elapsed, the unit must undergo a the general overhaul as prescribed by the maker.

Class of operation. In accordance with FEM classification, two fundamental criteria must be allowed for: the level of load and stress

of the hoist, and the operating categories (related to the average daily use and hoisting movement of the unit).

ISO standard. The utilisation groups can also be defined in terms of ISO groups (1Am = M4, 2m = M5, 3m = M6,....).

Load status.

> **Light duty service.** The unit is subjected to maximum loads only under exceptional circumstances, with very light loads the majority of the time.

> **Average duty service.** The unit handles maximum loads fairly often, and frequently light loads.

> **Heavy duty service.** The unit is frequently subjected to maximum loads and normally to average loads.

> **Very heavy duty service.** The unit is regularly subjected to loads approaching the maximum.

Average daily operating time (hours)			≤ 0,5		≤ 1		≤ 2		≤ 4		≤ 8		≤ 16		
Class of duty			V0,25	T2	V0,5	T3	V1	T4	V2	T5	V3	T6	V4	T7	
Type of service	1	L1	Light					1Bm	M3	1Am	M4	2m	M5	V4	M6
	2	L2	Medium			1Bm	M3	1Am	M4	2m	M5	3m	M6		
	3	L3	Heavy	1Bm	M3	1Am	M4	2m	M5	3m	M6				
	4	L4	Very heavy	1Am	M4	2m	M5	3m	M6						
Group							1Bm	M3	1Am	M4	2m	M5	3m	M6	
Duty factor**							25 %		30 %		40 %		50 %		
Number of start per hour							150		180		240		300		

■ F.E.M. 9511 standards classification ■ ISO standards.

* Operating factor in percentage terms = $\frac{\text{Hoisting time} + \text{Lowering time}}{\text{Hoisting time} + \text{Dwell time} + \text{Lowering time} + \text{Dwell}} \times 100$

Dimensions

Eurolift type	Number of falls	C in mm	
		Standard	Stainless steel
BH2	2	390	390
	3	435	465
	4	400	430

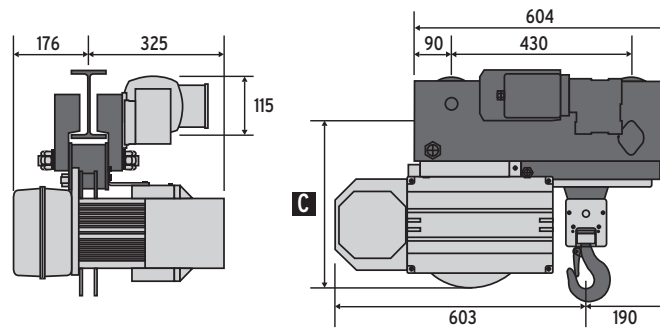

Range

Eurolift type	S.W.L (kg)	Group F.E.M.	Number of falls	Height of lift (m)	Lifting speed (m/min)	Travelling trolley			Lifting motor power (kW) 1.9 / 0.3 Travelling motor power (kW) 0.25 / 0.06
						Push trolley	Chain drive trolley	Motorized 1 speed trolley	
BH2 02 R3	500	1Bm	2	9,00	20 / 3,3	•	•	•	Lifting motor power (kW) 1.9 / 0.3 Travelling motor power (kW) 0.25 / 0.06
BH2 03 R5	500	2m	3	6,00	13 / 2	•	•	•	
BH2 02 L5	630	2m	2	9,00	10 / 1,6	•	•	•	
BH2 03 R4	630	1Am	3	6,00	13 / 2	•	•	•	
BH2 02 L4	800	1Am	2	9,00	10 / 1,6	•	•	•	
BH2 03 R3	800	1Bm	3	6,00	13 / 2	•	•	•	
BH2 02 L3	1000	1Bm	2	9,00	10 / 1,6	•	•	•	
BH2 03 L5	1000	2m	3	6,00	6,5 / 1	•	•	•	
BH2 03 L4	1250	1Am	3	6,00	6,5 / 1	•	•	•	
BH2 04 L5	1250	2m	4	4,50	5 / 0,8	•	•	•	
BH2 03 L3	1600	1Bm	3	6,00	6,5 / 1	•	•	•	
BH2 04 L4	1600	1Am	4	4,50	5 / 0,8	•	•	•	
BH2 04 L3	2000	1Bm	4	4,50	5 / 0,8	•	•	•	Lifting motor power (kW) 1,9/0,3 - 3,5/0,5 Travelling motor power (kW) 0,55
BH5 04/RN1	2500	2m	1x4	5,90	3,8/0,6	x	x	•	
BH5 04/RN2	3200	1Bm	2x2	8,20	5,9/0,9	x	x	•	
BH5 08/RN2	5000	1Am	2x4	5,90	3,8/0,6	x	x	•	0,55

• : available in this version

X : not available in this version

Range of loads

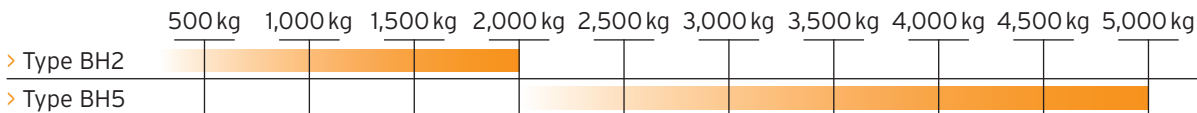

Explanation of EUROLIFT BH codification*

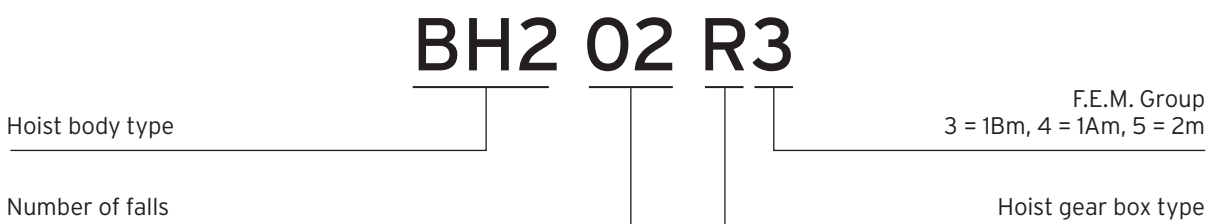

*Except BH5.



VERLINDE is:

- The leading French manufacturer and exporter of lifting and handling equipment.
- A comprehensive range of 30 groups of lifting equipment from 60 to 250,000 kg.
- ISO 9001 Quality control certified and ISO 14001 Environmental Management Systems.

In France:

A sales network and after sales service points, EUROPONT travelling crane construction plants and a distributor network.

Abroad:

A customer service in more than 92 countries.

References

Metallurgy, Mechanics, Nuclear
ArcelorMittal, Unimetal, Stein, NFM,
Framatome, Alstom

Chemicals, Petrochemicals industry
Sanofi Aventis, Total,
Du Pont De Nemours

Aeronautical industry
Aérospatiale, Airbus,
Snecma, Eurocopter,
Air France, Aéroport de Paris,
Dassault Aviation



Agri-food industry
Nestlé, Danone, Bel, Palamatic,
Tetrapak, Lactalis

Automobile industry
Renault, Peugeot, Citroën, Scania,
Ford, RVI, Volkswagen, Michelin,
Massey Ferguson, Manitou,
Toyota Industrial Equipment

Other sectors
EDF, SNCF, RATP, Spie, Degremont,
Eiffage, Polysius, Baudin Chateauf

 **VERLINDE**[®]
LIFTING EQUIPMENT

NEXT LEVEL
PARTNERSHIP

2, boulevard de l'Industrie | B.P. 20059 | 28509 Vernouillet cedex | France
Phone : (33) 02 37 38 95 95 | Fax : (33) 02 37 38 95 99 | Internet : www.verlinde.com

