

www.stagemaker.com

new
SAR

For loads from **250** up to **5000** kg

Raising
the Standard
of Performance

STAGE MAKER®

X2
DOUBLE
BRAKE
as standard
BGV D8+
READY

Product Distributed in Ireland by:



601, Western Industrial Estate, Dublin 12, Ireland
T: + 353 (0)1 4584836 E: sales@prolift.ie
www.prolift.ie

STAGEMAKER
SRS DOUBLE BRAKE

STAGEMAKER
SRS DOUBLE BRAKE



STAGEMAKER®

STAGEMAKER SR is the result of our vast experience in the entertainment market, along with well established R&D and relationships with our worldwide customer base.

1975



Launch of Europe's first inverted, electric powered hoist, the LITACHAIN L104 range

1990



Launch of the LITACHAIN LI 5 & LI10 range

1998



Launch of the STAGEMAKER SM range

2013



Launch of the new STAGEMAKER SR range

STAGEMAKER has an excellent global reputation with more than 38 years of experience in the entertainment rigging market as well as theaters, studios, events, trade show,... Our long life span, together with our impressive customer references, proves our commitment to this market and the reliability and ingenuity of our products.

Backed by this ongoing policy of innovation, constant upgrading in tune with current technologies and worldwide regulation (CE, DIN, CSA, GOST), the STAGEMAKER SR range of hoists will further prove that Stagemaker is Raising the Standard of Performance in the entertainment market.

STAGEMAKER®

SR

X2
DOUBLE
BRAKE
as standard
BGV D8+
READY



+ innovation



PERFECT PUSH™

> New "Perfect Push", patented concept, 5 pocket load wheel, fitted with 5 intermediate teeth. This innovation provides improved chain guiding and chain flow, to help reduce the risk of chain jamming.



reddot design award
product design 2013

+ safety

- > **Double lifting brake as standard** for more safety. Stagemaker SR is D8+ ready (after resetting nominal load, divided by 2).
- > Clutch concept. The clutch position in the reducer ensures the load is held by the brake regardless of the machine's daily operating conditions.
- > Electrical limit switch as standard on all SR5 and SR10 (version B) with standard Limitflux.
- > IP55 protection for the entire hoist.
- > Black electro galvanized lifting chain manufactured specifically for Stagemaker.
- > All hoist motor as integral thermal protection to prevent overheating (version B).



Optional equipment

- > Single phase model (SR1 and SR5).
- > Single brake.
- > Pushbutton controller.
- > 4, 8, 12,... channels controllers.
- > Low voltage control (48 V) version B.
- > Large range of flight cases.
- > Non rotating hook.
- > Suspension eye instead of upper hook.
- > Industrial chain guide.
- > Encoder.
- > Load measuring system.
- > VBG-C1,...
- > Rain cover protection.
- > Grade 100 lifting chain to increase safety factor.



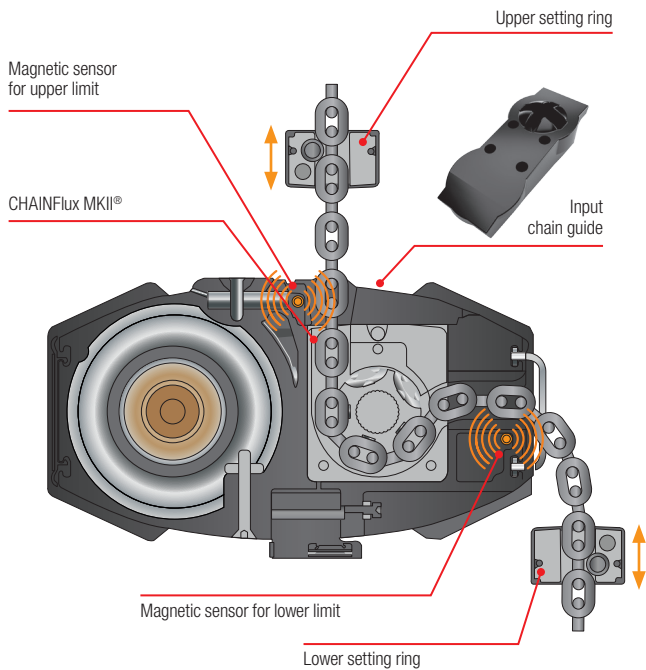

CHAINFLUX®

- > Design provides a horizontal flow of the chain as it comes off the load wheel. This design, along with the high strength aluminum construction, allows for a more fluid flow of the chain into the chain bag and helps to reduce the risk of chain jamming. Drain in housing to avoid water collection in load wheel compartment.



LIMITFLUX®

- > The Limitflux is a built-in limit switch device in the CHAINFlux MKII® that's allow to control setting of hoist or hook position in industrial suspension or climbing configuration.
- > Accuracy of the system is given at one link of lifting chain.
- > The setting of the limit is operated by two magnetic ring (upper and lower) which can be easily moved and set along the lifting chain.

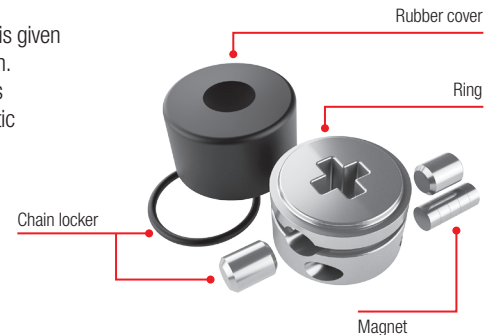

+ operating convenience

- > Operating sound level down to 60 db (test certificate available).
- > Climbing hoist or industrial suspension configuration can be changed simply by reversing the chain container.
- > Rotating upper and lower hooks.
- > High capacity and high strength chain bag made of 1100 denier, high grade black fabric, is both removable and reversible.
- > Rubber buffers located on the hoist corners provide added protection for the hoist.
- > Motor design provides consistent speeds when both fully loaded or unloaded.
- > Electrical components designed for "plug and play" connectivity.

+ savings

Maintenance operations are now simpler, faster and more economical:

- > Easy access to the torque limiter.
- > Easy access to safety fuses.
- > New concept of easily dismountable hoisting motor.
- > Easy visual access to the brake for control.

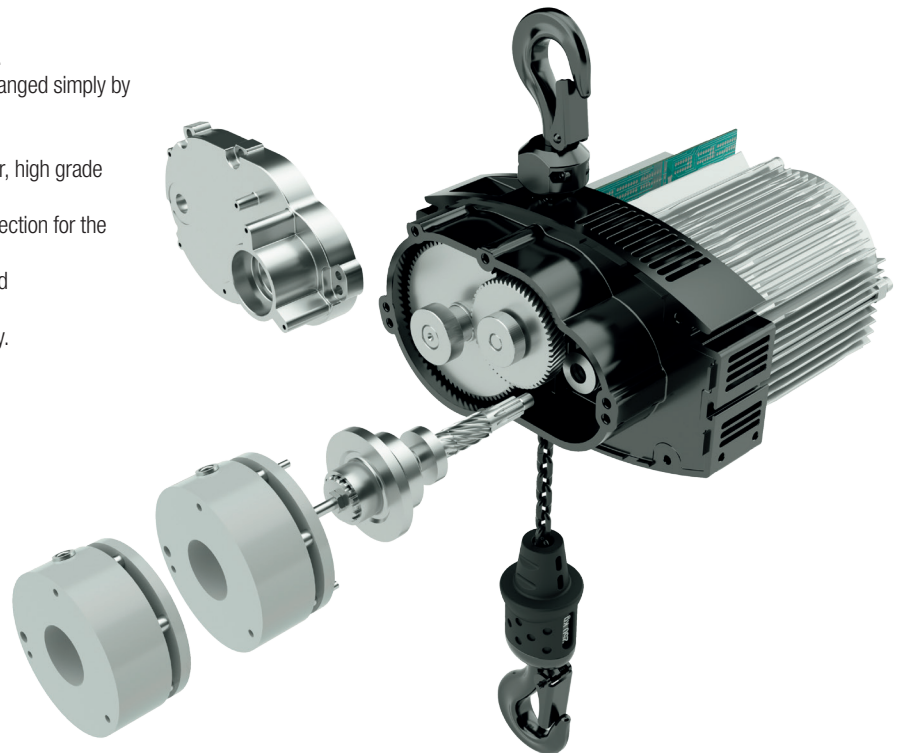

+ improved ergonomics

- > Due to oval shape the chain can't be stock on top of the motor, this reduce the risk of chain jamming. The design with its flowing and refined lines draws attention to its robustness and on-board technology and gives a strong impression of integral safety. The new streamlining provides STAGEMAKER SR better integration in its operating environment (lighting, loudspeakers, etc.).
- > Hoist meets ecology regulations and is RohS compliant.
- > The hoist body is powder coated with black (RAL 7021), protective 70 µm epoxy paint, allowing it to perform under the most extreme conditions (-20C° to +50 C° / -4 to 122 degrees F).
- > Lifting hook has an ergonomic, rubber clad, gripping surface.

- > New ergonomic concept for the retractable, rubber clad handgrips, allow an easy transportation of the hoist (SR2, SR5 and SR10).
- > Black CE P17 plug for better integration.



Range

SR1

For loads from **250** up to **500** kg



SR2

For loads up to **320** kg



SRS

For loads up to **500** kg



SR10

For loads from **1000** up to **2000** kg



SR25

For loads from **2500** up to **5000** kg



Operating configurations

CLIMBING HOIST
CONFIGURATION



INDUSTRIAL
SUSPENSION HOIST
CONFIGURATION



STAGEMAKER® SR1 at a glance

Small but **powerful**
250 kg on one fall!

X2
DOUBLE
BRAKE
as standard
BGV D8+
READY

Technical characteristics

- > 1 fall (250 kg) or 2 falls hoist (500 kg).
- > Lifting speed : 4 m/min (1 fall).
- > Center to center hoist.
- > Clutch on the safe side.
- > Same iconic design that actual SR range (oval shape).
- > Hoist body : 100% aluminum body, no plastic parts.
- > Double brake as standard
- > Rotating upper and lower hooks.
- > DIN hooks.
- > Rubber ergonomic grip on top hook.
- > IP55 Protection.
- > 4x11 chain (same chain as SR2).
- > Available in Version A (direct control),
Version B (Low voltage control).
- > Black CE P17 plug for better integration.
- > Black lifting chain.
- > Free maintenance brake.
- > RAL7021 epoxy paint.
- > Climbing hoist or industrial suspension configuration
can be changed simply by reversing the chain
container.
- > **PERFECT PUSH**. New patented concept,
5 pocket load wheel, fitted with 5 intermediate teeth.
This innovation provides improved chain guiding and
chain flow, to help reduce the risk of chain jamming.
- > **CHAINFLUX** as standard. Horizontal
ejection of the chain.
- > Electric limit switch (on B version).

Options

- > Single phase.
- > Version A or B.
- > Handles.



new
Single phase
version
available

Stagemaker SR1	1 fall	2 falls
SWL (kg)	250	500
Dimensions	Best dimensions on the market with 1 or 2 brakes	Best dimensions on the market with 1 or 2 brakes
Body weight (kg)	10,4	10,4
Sound level	50 db	50 db
Integration into 12" truss	Yes	Yes
Double brake as standard	Yes	Yes
Chainflux as standard	Yes	Yes
PerfectPush as standard	Yes	Yes
Electric limit switch as standard	Yes (on low voltage type B version)	Yes (on low voltage type B version)
Versatile use of the hoist (Climbing hoist or industrial suspension)	Yes (just by reversing the hoist)	Yes (just by reversing the hoist)

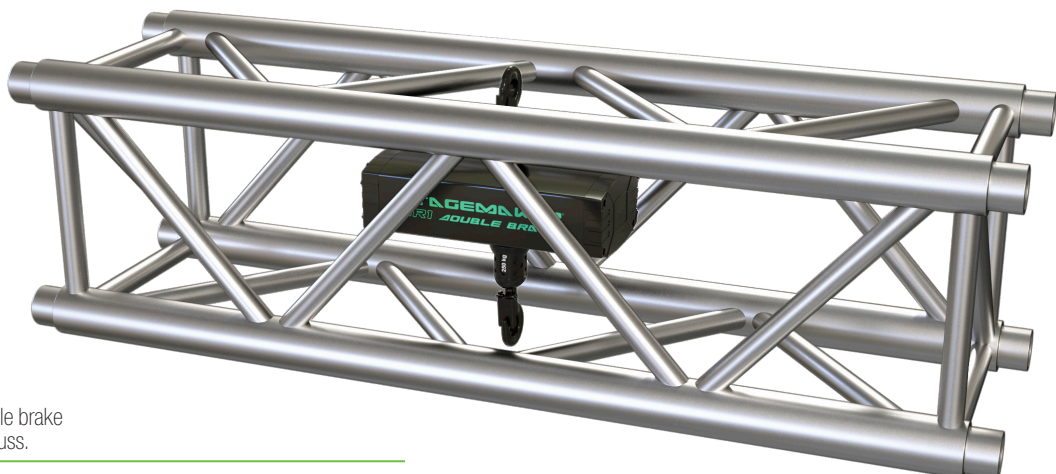

Stagemaker SR1 double brake
fits perfectly in a 12" truss.

Types of control and technical characteristics*

Features / Versions

Version A : motor 3 phases with direct control

Version B : motor 3 phases with low voltage control

3 phase hoists (400 V/415 V/3 Ph/50 Hz) with direct voltage control (ACF board)	●	▲
3 phase hoists (400 V/415 V/3 Ph/50 Hz) with low voltage control (48V)	▲	●
BGV-D8 version	●	●
BGV-D8+ "ready" version	● ⁽¹⁾	● ⁽¹⁾
Complies with standards : CE, CSA, GOST	●	●
Easy changeover for using motor in climbing hoist configuration or industrial suspension	●	●
Hoist delivered with black electro galvanized chain (except SR25)	●	●
"CHAINFlux® MKII" specially designed chain guide	●	●
"Limitflux®" : magnetic limit switch (SR5 and SR10 1 fall)	▲	●
Electric limit switch on SR1, 2, 10 (2 falls) and 25	▲	●
Electric limit switches (for version with industrial chain guide)	▲	○
"PerfectPush®" : new load wheel with 5 pockets and 5 intermediate guide teeth	●	●
Class F hoisting motor	●	●
Adjustable torque limiter	●	●
2 brake system	●	●
1 brake system	○	○
Self adjusting, maintenance free, DC disk brake	●	●
Available power supply : 460 V/3 Ph/60 Hz	○	○
Available power supply : 230 V/1 Ph/50 Hz (SR1 & SR5)	▲	○
Black painted hoist body (RAL 7021)	●	●
Rotating upper and lower hooks	●	●
Upper hook fixed and lower hook rotating (industrial suspension configuration)	○	○
Retractable, rubber clad ergonomic handgrips (except SR1 in option and not available on SR25)	●	●
Lifting hook has an ergonomic, rubber clad, gripping surface	●	●
High capacity, reversible chain bag	●	●
Standards connection cable : CE plug P17 type, 4 poles 16A (red : power supply/control)	●	▲
CE plug P17 type, 4 poles 16A (red : power supply and yellow : control)	▲	●

● Standard ○ Option ▲ Not available

⁽¹⁾ After setting of hoist torque limiter to obtain nominal load divided by 2.

Specifications

Load capacity	D8 Models (D8+ Ready)	D8+ Models	Hoist speed 50Hz	Number of falls	Chain size (mm)	Motor power kW	Dimensions with 2 brakes			Weight of hoist body without chain (kg)	Weight of lifting chain per m [®] (kg)
							A mm	B mm	C mm		
125	nouveau	SR1 124 m1 A	4	1	4 x 11	0,19	344 ⁽¹⁾	153	100	10,4	0,37
		SR5 1216 m1 A	16	1	5 x 14	0,45	502 ⁽²⁾	280	164	30,5	0,56
160	nouveau	SR2 164 m2 A	4	1	4 x 11	0,23	477 ⁽²⁾	240	140	20,1	0,37
		SR2 168 m2 A	8	1	4 x 11	0,45	477 ⁽²⁾	240	140	20,1	0,37
250	nouveau	SR1 254 m1 A	4	1	4 x 11	0,19	344 ⁽¹⁾	153	100	10,4	0,37
		SR1 252 m1 A	2	2	4 x 11	0,19	344 ⁽¹⁾	153	100	10,4	0,37
		SR5 254 m2 A	4	1	5 x 14	0,45	502 ⁽²⁾	280	164	30,5	0,56
		SR5 258 m2 A	8	1	5 x 14	0,9	502 ⁽²⁾	280	164	30,5	0,56
320	nouveau	SR5 2516 m1 A	16	1	5 x 14	0,9	502 ⁽²⁾	280	164	30,5	0,56
		SR10 2516 m1 A	16	1	7 x 20	1,8	544 ⁽⁴⁾	335	181	44,6	1,1
		SR2 324 m2 A	4	1	4 x 11	0,23	477 ⁽²⁾	240	140	20,1	0,37
		SR2 328 m1 A	8	1	4 x 11	0,45	477 ⁽²⁾	240	140	20,1	0,37
500	nouveau	SR1 502 m1 A	2	2	4 x 11	0,19	344 ⁽¹⁾	153	100	10,4	0,37
		SR5 504 m1 A	4	1	5 x 14	0,45	502 ⁽²⁾	280	164	30,5	0,56
		SR10 504 m2 A	4	1	7 x 20	0,9	544 ⁽⁴⁾	335	181	44,6	1,1
		SR5 508 m1 A	8	1	5 x 14	0,9	502 ⁽²⁾	280	164	30,5	0,56
800	nouveau	SR10 508 m1 A	8	1	7 x 20	1,8	544 ⁽⁴⁾	335	181	44,6	1,1
		SR10 516 m1 A	16	1	7 x 20	1,8	544 ⁽⁴⁾	335	181	44,6	1,1
		SR10 804 m1 A	4	2	7 x 20	1,8	544 ⁽⁴⁾	335	181	44,6	1,1
1000	nouveau	SR10 1004 m2 A	4	1	7 x 20	0,9	544 ⁽⁴⁾	335	181	44,6	1,1
		SR10 1004 m1 A	4	2	7 x 20	1,8	544 ⁽⁴⁾	335	181	44,6	1,1
1250	nouveau	SR10 1008 m1 A	8	1	7 x 20	1,8	544 ⁽⁴⁾	335	181	44,6	1,1
		SR25 1204 m1 A	4	1	11,3 x 31	3,6	649 ⁽⁵⁾	393	205	98	2,85
1600	nouveau	SR25 1208 m1 A	8	1	11,3 x 31	3,6	649 ⁽⁵⁾	393	205	98	2,85
		SR10 1604 m1 A	4	2	7 x 20	1,8	544 ⁽⁴⁾	335	181	44,6	1,1
2000	nouveau	SR10 2004 m1 A	4	2	7 x 20	1,8	544 ⁽⁴⁾	335	181	44,6	1,1
		SR25 2504 m2 A	4	1	11,3 x 31	3,6	649 ⁽⁵⁾	393	205	98	2,85
		SR25 2504 m1 A	4	2	11,3 x 31	3,6	649 ⁽⁵⁾	393	205	98	2,85
2500	nouveau	SR25 2508 m1 A	8	1	11,3 x 31	3,6	649 ⁽⁵⁾	393	205	98	2,85
		SR25 5004 m2 A	4	2	11,3 x 31	3,6	649 ⁽⁵⁾	393	205	98	2,85

⁽¹⁾ Simple brake version D8 : A = 307 mm.

⁽²⁾ Simple brake version D8 : A = 425 mm.

⁽³⁾ Simple brake version D8 : A = 472 mm.

⁽⁴⁾ Simple brake version D8 : A = 507 mm.

⁽⁵⁾ Simple brake version D8 : A = 587 mm.

⁽⁶⁾ For double fall model multiply value by 2.

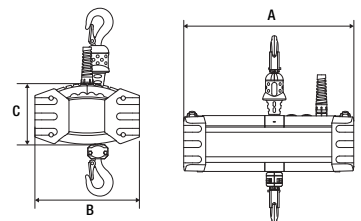



STAGEMAKER® Controllers

The STAGEMAKER® Controllers has been specifically developed for the control of STAGEMAKER® VERLINDE motors (chain hoist) of the SR series. 3 Ranges are available from our catalog ECO, RIGGER, THEATER. The controllers come with 4, 8 or 12 channels and can be integrated in a compact flight case (19" rack 3U to 6U) or a vertical flight case depending on the model. The STAGEMAKER® Controller allows you to control the show motors individually or by group by simply pressing a button. Motor pre-selection system for each control unit, selection panel / remote control comes as standard feature.

The STAGEMAKER® motors equipped with options such as : low voltage control, adjustable limit switch and thermal protection for lifting motor can also be controlled by this system using a single power supply cable. For larger applications, STAGEMAKER® Controllers can be connected together with master/slave functionality. All the motors selected will be activated simultaneously by a single button.

Other configurations are available on request.

The STAGEMAKER® Controller satisfies the current European safety standards relative to electrical equipment (IEC & EMC) and has been approved by official European institutes. These control systems provide the user with a high level of flexibility, durability and safety.

> Controller Eco

ECO, as indicated by the codification name, this range offer best equipment/price approach.

- > Solid state direct control controller in steel case for 4 or 8 channels.
- > Size : Rack 19" wide, 3U (4 ch.) and 6U (8 ch).
- > Power supply : 400/ 415 V 3PH+N – 50/60Hz.
- > Power-in plug 32 A 5p CE.
- > Phase monitoring indicating lamp.
- > Multi connector output for each group of 4 motors.
- > In addition, CE form 4p 16A out per hoist channel.
- > Short circuit protections : power & control circuit.
- > Thermal protection per group of 4 motors.
- > Max. power per channel : 1,8 kW / 400 V 3 Ph.

Options available

- > Dedicated flight case in 19", 3U or 6U format available.

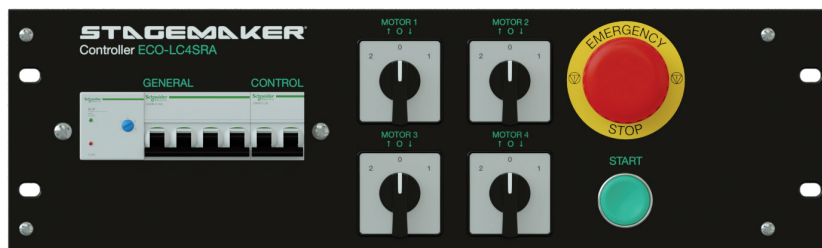

Range	Connector	Model
Controller Eco Rack 19" - 4 channels	1 x 16 multi connector + 4 x 4p CE	ECO-LC4SRA
Controller Eco Rack 19" - 8 channels	2 x 16 multi connector + 8 x 4p CE	ECO-LC8SRA

> Controller Rigger Suitcase

RIGGER, this range of controller in suitcase is designed for our A STAGEMAKER RANGE (Direct control).

- > Phase detection and automatic correction of the phases.
- > Standard built in Master/slave functionality.
- > Power supply : 400/ 415 V 3PH+N – 50/60Hz.
- > Power-in plug 32 A 5p CE.
- > P17 CE form 4p 16 A out for controllers in a hand case.
- > Short circuit protections : power & control circuit.
- > Thermal protection per group of 4 motors.
- > Max. power per channel : 1,8 kW / 400v 3 Ph.
- > High quality ABS professional Suitcase (Pelicase or equivalent).



Range	Connector	Model
4 ch. compact controller in suitcase	4p CE	SC4SR
8 ch. compact controller in suitcase	4p CE	SC8SR



STAGEMAKER® Controllers

> Controller Rigger Rack 19"

RIGGER, this range of 19" controller rack is designed for our A STAGEMAKER RANGE (Direct control).

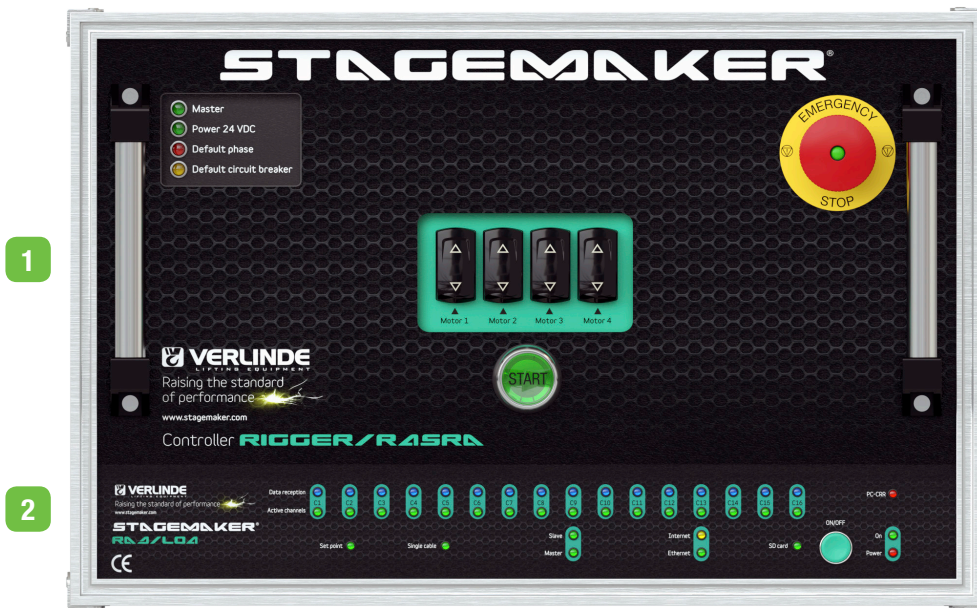

Example of configuration :

- 1 Controller Rigger R4SRA 4 channels direct control.
- 2 Central Radio Receiver for radio load cell.
- 3 Wired remote control.

- > Phase detection and automatic correction of the phases for all the range RIGGER.
- > Standard built-in cabling for possible remote (wired or wireless) for all the range RIGGER rack 19".
- > Standard built in Master/slave functionality.
- > Power supply : 400/ 415 V 3PH+N – 50/60Hz.
- > Power-in plug 32 A 5p CE.
- > Multi connector output one for each 4 motors.
- > 24/48 Vdc control voltage.
- > Short circuit protections : power & control circuit.
- > Thermal protection per group of 4 motors.
- > Max. power per channel : 1,8 kW / 400 V 3 PH.

Range	Connector	Model
Controller Rigger rack 19" - 4 channels	1 x 16 multi connector	R4SRA
Controller Rigger rack 19" - 8 channels	2 x 16 multi connector	R8SRA
Controller Rigger rack 19" - 12 channels	3 x 16 multi connector	R12SRA

Options available

- > **Wired remote control** : remote for 4, 8 and 12 channels controller (25 m of cable).
- > **Radio remote control** : 32 channels radio receiver 19" and remote emitter for controller type R4SRA, R8SRA or R12SRA.

- > **Load measuring** : XLR connector and 2 m cable for connection to Set point, for integration of STAGEMAKER LOAD CELL system. 19" rack central radio receiver for load cell.
- > **Flight cases** : large choice of Flight case 19" available in Premium or Eco version (see page Flight cases).

Rubber protection and carrying belt for Radio transmitter 32 channels.



HF offset kit to improve radio reception in case of disturbed transmission with radio remote control option.

Radio receiver is equipped as standard with a slot for the remote storage.



Feature deliver as standard on Rigger and Theater Range : visual monitoring of the emergency stop button status.



>Controller Theater Rack 19"

THEATER, this family of controller is designed for our B STAGEMAKER RANGE (Low voltage control).

1



2



3

Example of configuration :

- 1 Controller Theater R12SRB 12 channels low voltage control.
- 2 Central Radio Receiver for remote control.
- 3 Radio emitter for remote control.

- > Phase detection and automatic correction of the phases for all the range THEATER.
- > Standard built-in cabling for possible remote option (wired or wireless) for all the range THEATER.
- > Standard built in Master/slave functionality.
- > Power supply : 400/415 V 3PH -N – 50/60Hz.
- > Power-in plug 32 A 5p CE.
- > 6 poles connectors output per hoist (type HE6).
- > 24/48 Vdc control voltage.
- > Short circuit protections for power and control circuit.
- > Thermal protection per group of 4 motors.
- > Max. power per channel : 1,8 kW / 400 V 3PH.

Range	Connector	Model
Controller Theater rack 19" - 4 channels	4 x 6p multi connector	R4SRB
Controller Theater rack 19" - 8 channels	8 x 6p multi connector	R8SRB
Controller Theater rack 19" - 12 channels	3 x 32p multi connector	R12SRB

Options available

- > **Wired remote controled** : remote for 4, 8 and 12 channels controller (25 m of cable).
- > **Radio remote control** : 32 channels radio receiver 19" and remote emitter for controller type R4SRB, R8SRB or R12SRB.
- > **C1** option for controller rack 19", in version 4, 8 or 12 channels (option available only at order step, no possible retrofit).
- > **Altmetry measure and automation** : additional module for individual or group hoist positioning managment. To be integrate with B type hoist with built-in encoder.
- > **Load measuring** : XLR connector and 2 m cable for connection to Set point, for integration of STAGEMAKER LOAD CELL system.
- > **Flight cases** : large choice of Flight case 19" available in Premium or Eco version (see page Flight cases).



Cables, accessories & tools

- > Pushbutton controller for 1 or 2 motors (version A only).
- > Connection cable for 2 controllers (Master/Slave connection).
- > Splitter box to connect up to 5 controllers.
- > Multiple connection cable for motors :
 - P17 red plug for control & power supply of the hoist (10 or 20 m).
 - P17 red plug for power supply of the hoist (10 or 20 m).
 - P17 yellow plug for control of the hoist (10 or 20 m).
- > Splitter fan in or out (Multiple connector, P17 red, P17 yellow,...).
- > Splitter fan in or out (harting, P17 red, yellow,...)
- > Remote control with emergency stop for 1 or 2 channels.
- > Remote control with pickle shape (version B only).
- > Rain cover for lifting unit.
- > Maintenance tool for lifting unit.

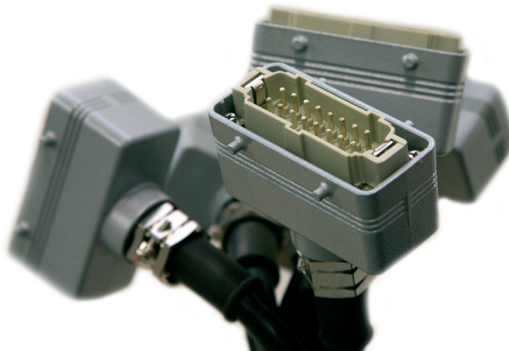





STAGEMAKER®

Soft steel

- > 2000 kg SWL (SF 5/1).
- > Black cover.
- > Safety factor 5:1.
- > 24 x 2 mm 7 x 19 SWR.
- > Double copper ferrule.
- > Inspection-hole with Velcro cover.
- > EN 13414-1 & EN 13411 & EN 13411-1*.
- > Grey identification label with user instruction, CE certification, and technical datas in English.
- > BGV-C1 Approval**.

* Where applicable.
 ** With german label only.

Weight capacity (SF 5/1) (kg)	Weight capacity (SF 10/1) – C1 (kg)	Work length (m)*
2000	1000	0.5
2000	1000	1.0
2000	1000	1.5
2000	1000	1.6
2000	1000	2.0
2000	1000	2.5
2000	1000	3.0

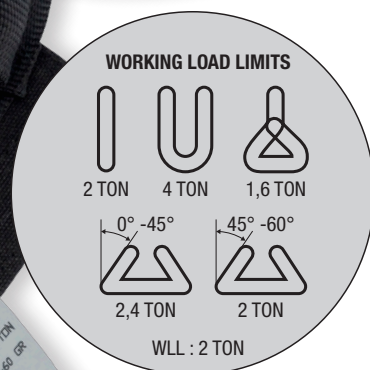

STAGEMAKER®

Radio load cell

Wireless system for load measuring

Advantages

- > Completely wireless: No messy cables & higher reliability: Multiple channels ensure reliable transmission. Each load cell transmits independently no danger of damage to one cable that will ruin the entire system ability to monitor the loads. STAGEMAKER RADIO LOAD CELL's very long battery life enables complete independence of the power system. This, together with UPS (Uninterruptable Power Supply) to backup the central radio receiver, enables continuous load monitoring even in power shut down. Especially suitable for touring and rentals.
- > With SRLI : one-time installation and then the load cell can stay as integral part of the hoist during entire tours, saving the installation time.
- > Very low headroom loss.
- > Up to 200 load cells on one Central Radio Receiver.
- > Load cells are available with a safety factor of 5 or 10.
- > No need for any extra accessories like shackles with SRLI.
- > Enables easy retrofit to all existing hoists that are in the market (entertainment and industrial).
- > Will make the periodical maintenance / service of the hoist easier.
- > Enables 5000 hours battery life, optional 10,000 hours i.e. more than a year of continuous use, no sleep mode or standby mode which are not acceptable from a safety point of view.

Range SRLM, SRLI and SRLC load cell

Model	0 kg	250 kg	500 kg	1000 kg	2000 kg	2500 kg	5000 kg	Dedicated hoist
SRLM/SRLI/SRLC 25	██████████████████							Stagemaker SR1/SR2
SRLM/SRLI/SRLC 50	██████████████████████████████							Stagemaker SR2/SR5/SR10
SRLM/SRLI/SRLC 100	██████████████████████████████████████							Stagemaker SR10
SRLM/SRLI/SRLC 200	██							Stagemaker SR10/SR25
SRLM/SRLI/SRLC 250	██							Stagemaker SR25
SRLM/SRLI/SRLC 500	██							Stagemaker SR25

Options

- > **Set point**, for integration of STAGEMAKER LOAD CELL system with any controller (use option XLR on Controller price list).
- > **Real time cellular SMS alert** on overload occurrence.
- > **Additional channel** : Per load cell, per channel or Per Central Radio Receiver, per channel. Explanation about the dual triple and quad frequency channels : each STAGEMAKER LOAD CELL will come standard with 2 frequency channels. Two additional channels may be added as an optional feature. The system will switch between channels once per second and will continuously cycle through all available channels while in operation. The dual system will simply switch between channels, when using three or four channels the system will run through all the channels in order. This cycling through the channels increases safety and reliability. If one channel is blocked due to environmental interference, the system will receive a reliable reading on an alternative channel within one second. This will negate the possibility of not receiving transmission.
- > **Single wire option** for the wireless receiver.
- > **Slave & master Central Radio Receiver** for increased range, harsh conditions, and the ability to monitor several halls in one control room : slave Central Radio Receiver (Laptop not included). Master Central Radio Receiver (Laptop included).

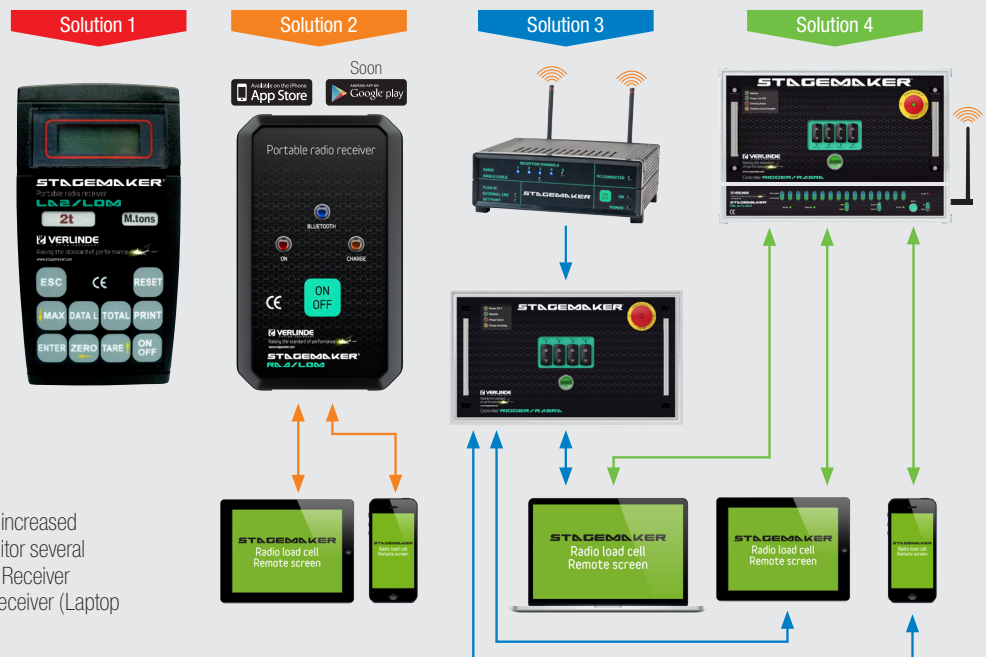
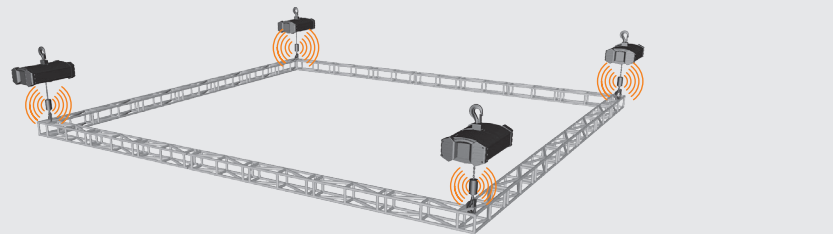



> **SRLM**
Stagemaker
radio load cell
on Stagemaker SR with shackles



> **SRLI**
Stagemaker
radio load cell
integrated on Stagemaker SR
lifting chain



> **SRLC**
Stagemaker
radio load cell
compact
integrated on Stagemaker SR
suspension hook

Storage options

In ABS suitcase



In a 19" drawer rack flightcase



STAGEMAKER®

Flight cases

A broad range of flight cases specially designed for the STAGEMAKER® motors and controllers is available.

STAGEMAKER® SR hoist range of flightcases

>Premium

- > Configuration type "trunk".
- > Top hinge cover
- > Panel all Birch shot 9 mm finish hexa black ultra resistant.
- > 2 fasteners recessed Butterfly (PENN).
- > 2 stop cover (PENN).
- > 8 recessed spring-loaded handles (PENN).
- > 4 casters 2 locking on turntables D100.
- > 4 cup stacking.
- > Tipage pads on the sides.

- > 2 visualization windows.
- > Sticker STAGEMAKER® Marking.
- > Sticker production plate.

Inside disposition

- > Mobile Cribs
- Sheet for easy version or double brake (ajustables).
- > 2 Trays chain at the center.



Designation	Dimensions (mm)
Flight case for 2 x SR1 (simple or double brake)	510 x 410 x 550
Flight case for 4 x SR1 (simple or double brake)	760 x 510 x 550
Flight case for 6 x SR1 (simple or double brake)	1110 x 510 x 550
Flight case for 1 x SR2 (simple or double brake)	575 x 575 x 540
Flight case for 2 x SR2 (simple or double brake)	910 x 575 x 540
Flight case for 1 x SR5 (simple or double brake)	615 x 600 x 540
Flight case for 2 x SR5 (simple or double brake)	1130 x 595 x 605
Flight case for 1 x SR10 (simple or double brake)	660 x 630 x 590
Flight case for 2 x SR10 (simple or double brake)*	1200 x 630 x 655
Flight case for 1 x SR25 (simple or double brake)	800 x 600 x 755

* Not recommended cause of final weight, please prefer solution of flight case solo.

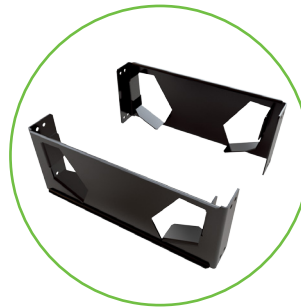

Perfect shape of the brackets to secure the hoist at bumper level.

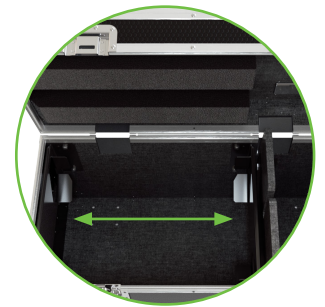

Adjusting brackets to fit with hoist configuration (1 or 2 brakes).

>Eco

- > Configuration type "trunk".
- > Cover top hinge.
- > Panel all Birch shot 9 mm.
- > 2 fasteners recessed Butterfly (PENN).
- > 2 stop cover (PENN).
- > 4 recessed spring-loaded handles (PENN).
- > 4 casters 2 locking on turntables D100.

- > Sticker STAGEMAKER® Marking.
- > Sticker production plate.

Inside disposition

- > Mobile Cribs Sheet for easy version or double brake (ajustables).
- > 2 trays chain at the center.

Designation	Dimensions (mm)
Flight case for 2 x SR1 (simple or double brake)	510 x 410 x 550
Flight case for 4 x SR1 (simple or double brake)	760 x 510 x 550
Flight case for 6 x SR1 (simple or double brake)	1110 x 510 x 550
Flight case for 1 x SR2 (simple or double brake)	575 x 575 x 540
Flight case for 2 x SR2 (simple or double brake)	910 x 575 x 540
Flight case for 1 x SR5 (simple or double brake)	615 x 600 x 540
Flight case for 2 x SR5 (simple or double brake)	1130 x 595 x 605
Flight case for 1 x SR10 (simple or double brake)	675 x 645x 590
Flight case for 2 x SR10 (simple or double brake)*	1200 x 630 x 655
Flight case for 1 x SR25 (simple or double brake)	800 x 600 x 755

* Not recommended cause of final weight, please prefer solution of flight case solo.



> Base

- > Type tray handling.
- > Panel all Birch black.
- > 2 handles pierced in the side posts.
- > Stacking bins, 2 skates on top.
- > Separate storage area for the chain.
- > Sticker STAGEMAKER® Marking.

Designation	Dimensions (mm)
Tray handling for 1 x SR2 (simple or double brake)	470 x 540 x 405
Tray handling for 1 x SR5 (simple or double brake)	515 x 580 x 405
Tray handling for 1 x SR10 (simple or double brake)	650 x 600 x 440



STAGEMAKER® SR controller range of flightcases

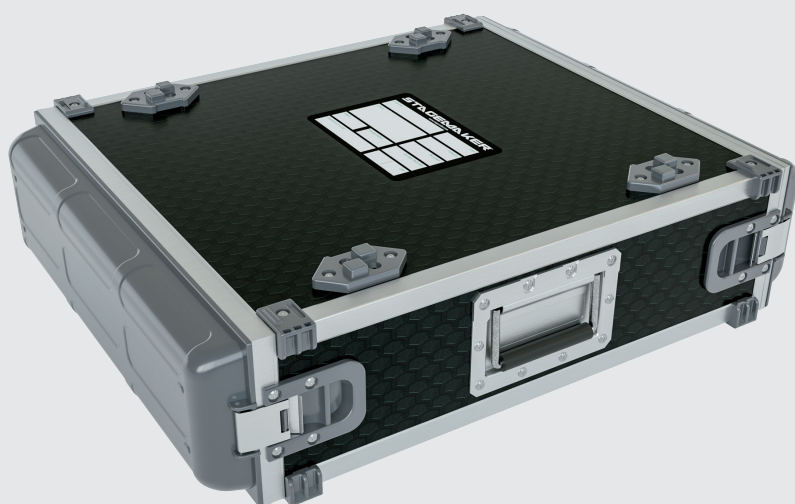

> Premium

- > Configuration type flat flight case for Rack 19" and multiple of U dimensions.
- > Front and back moulded plastic cover.
- > Panel all Birch shot 9 mm finish hexa black ultra resistant.
- > 4 recessed spring-loaded handles.
- > 4 cup stacking.

Inside disposition

- > Controller push inside along rail in drawer position type.

> Eco

- > Configuration type flat flight case for Rack 19" and multiple of U dimensions.
- > Front and back moulded plastic cover.
- > Panel all Birch shot 9 mm.
- > 4 recessed spring-loaded handles.
- > 4 cup stacking.

Inside disposition

- > Controller push inside along rail in drawer position type.

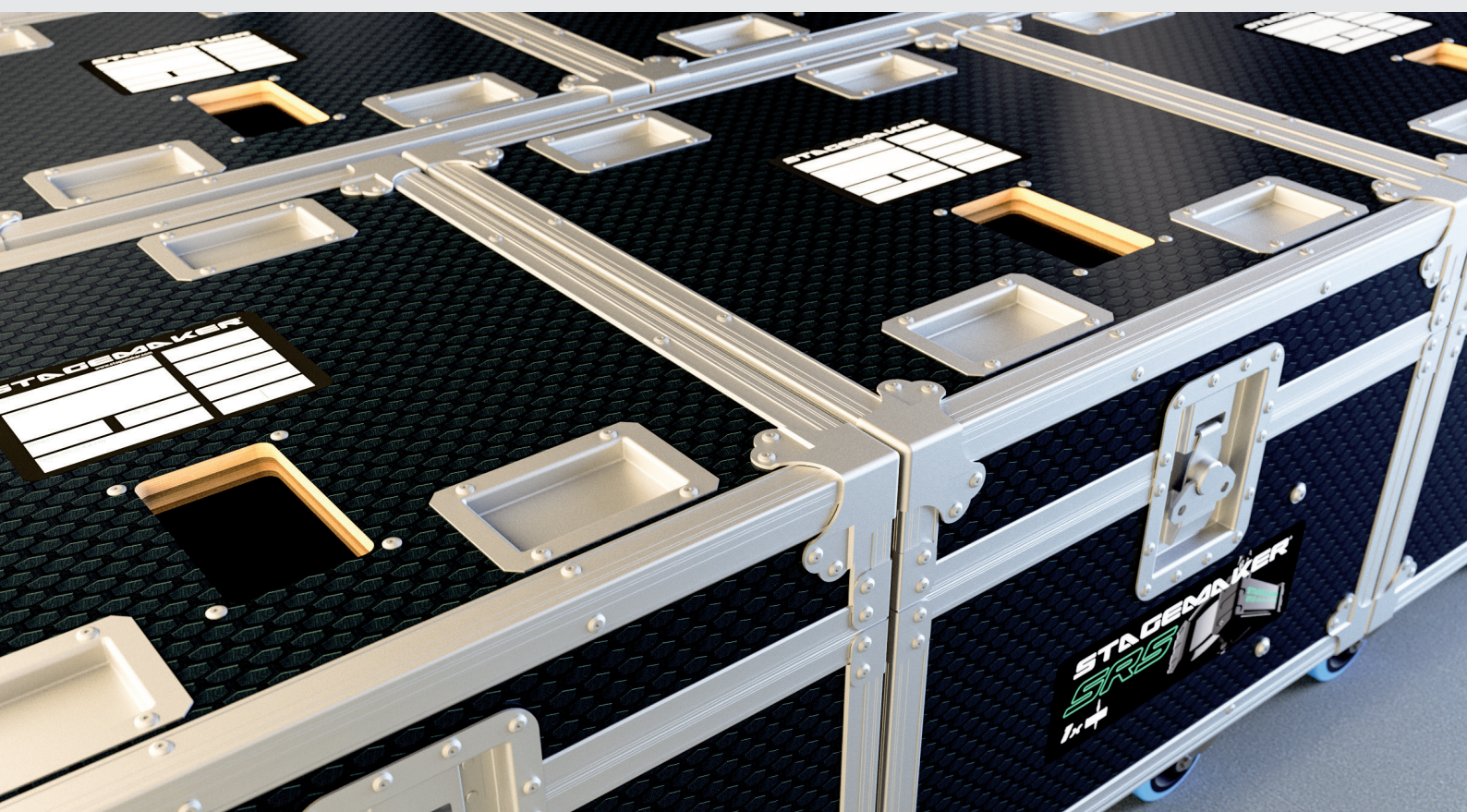

Cable guide

> Premium : Chainrunner

powered by

STAGEMAKER®



The ChainRunner is used to manage power, control, audio and data cables associated with moving truss applications, eliminating the necessity for very expensive spring driven cable reels and eradicating the home made gizmos that abound in the industry. The ChainRunner is simple to fix with no need to remove chain or hook from the chain hoist and no additional tooling is required.

Once fitted the ChainRunner cannot become disconnected from the chain whilst under load. By placing an adequate number of ChainRunners on the chain, any attached cables will neatly and safely loop in and out as the truss is moved.

Chainrunner Premium

Chain dimensions

Produce according customer request

Hoist type

Stagemaker SM1/SM2/SM5/SM10/SM16/20
Stagemaker SR1/SR2/SR5/SR10/SR25

- > Unique size.
- > Dimensions : 65 x 45 mm approx.
- > Weight : 142 gr approx.
- > SWL : 20 kg.
- > Manufactured from 6063 T5 Aluminium.
- > Finish : black anodised aluminium.
- > Marquage par gravure laser.
- > Designed & Manufactured to ISO 9001-2001.



Chainrunner partially deployed



Chainrunner fully extended



Chainrunner fully retracted

> Eco : Tourslider



- > 2 models : M & L.
- > 1 fixing point (10 mm).
- > Designed to work with Industry standard hoist.
- > Made out of low friction Black Polyoxymethylene (POM).
- > Toolless installation.
- > Installation w/o disassembly of the 2 plastic parts, chain or hook.
- > Not available for sales in UK and USA.



> Eco : Chainslider

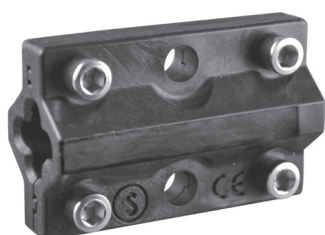

- > 3 models : S, M & L.
- > Dual 9 mm cable attachment points.
- > Designed to work with Industry standard hoist.
- > Made out of low friction Black Polyoxymethylene (POM).
- > CE marked.
- > Not available for sales in UK and USA.

Chainslider Eco and Tourslider Eco

Designation	Chain dimensions	Hoist type
Chainslider S	4 < 5,5 mm	Stagemaker SM1/SM2/SM5 Stagemaker SR1/SR2/SR5
Chainslider M Tourslider M	5,5 < 7 mm 6,1 < 7,2 mm	Stagemaker SM10 Stagemaker SR10
Chainslider L Tourslider L	7,5 < 9 mm 7,9 < 9 mm	Stagemaker SM16

STAGEMAKER®

Load fall arrester

>Premium



STAGEMAKER LOAD FALL ARRESTER PREMIUM is a complete automatic device using the latest mechanical concepts which mainly has been approved on thousands of devices now available worldwide. All units are made out of a steel housing with esthetical color and shape. Internal parts like axles, ratchet, bearing, shaft and drum are made of high mechanical resistance steel and offer best corrosion proof due to paint treatment.

- > Housing : corrosion treated steel.
- > Screws and bolts : zing plated steel.
- > Locking system : with 2 pawls.
- > Type of cable : galvanised.
- > Standard working speed : 20 m/min.
- > Maximum stopping distance : < 60 cm.
- > Maximum number of cycles : max. 50 cycles a day.
- > CE marked.

Premium light range	
Load (kg)	Cable length (m)*
250	10
250	15
250	20
250	30
500	10
500	15
500	20

* Other length on request.

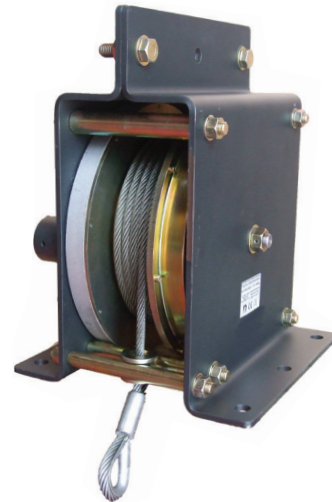

Premium heavy range	
Load (kg)	Cable length (m)*
1000	12
1000	25
1500	10
1500	25
2000	10
2000	20
2500	10
2500	17

* Other length on request.

>Eco

STAGEMAKER LOAD FALL ARRESTER ECO, as indicated by codification name, this range of stop fall offer the best equipment/price approach.

- > Type of cable : steel galvanized.
- > Body frame from Polymer high duty, virtually indestructible.
- > Breaking point : > 3 k.
- > Connector : 2 carabiners with screw locking device.
- > CE marked : 2006/42/CE.

Eco light range	
Load (kg)	Cable length (m)*
250	10
300	10
300	15
400	10
400	15
400	20
500	10
500	15

* Other length on request.



Other products

> Hand chain hoist VHR®

For loads from **500** kg to **1000** kg

The VHR is a compact, high-performance hand chain block with rugged good looks, tested according to official applicable standards.

- > Machined chain sprocket and gears provide smoother, more efficient operation.
- > 3 meters standard lift. Hand chain is 0.5 meters less than lift chain. Non-standard lifts available.
- > High strength grade 80 alloy steel load chain with galvanized finish for corrosion resistance (comply with EN 818, safety factor 4).
- > VHR's compact design offers safety together with reduced weight. Ideal for construction and maintenance applications.
- > Steel casing solidly protects chain sprocket, gearcase and handwheel cover.
- > Hooks are alloy steel, heat treated and equipped with hook latches and inspection points.
- > Weston type load brake mechanism.
- > High-resistance RAL 7021 powder coating, 70 µ thick.
- > Delivered with CE certificate, and hook and chain certificate.

Option : A wide range of options is available for this hand chain block :

- > VHR is stainless steel lift chain and hand chain.
- > Chain bag.

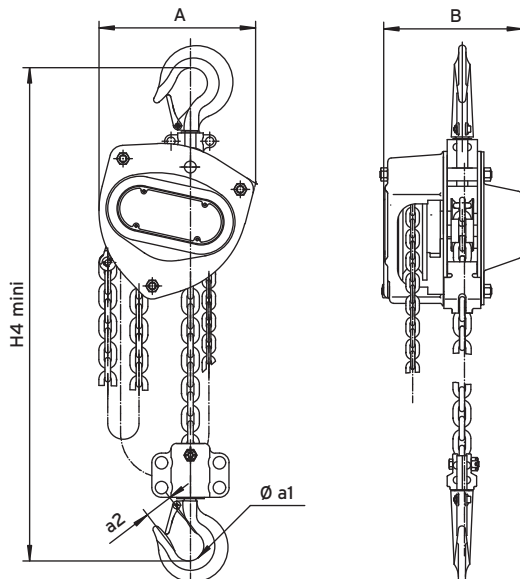

Load	A	B	Øa1	a2	H4 mini	Chain	Number of fall	Pulling force (kg)	Weight (kg)
500 kg	148	132	35	23	345	5 x 15	1	35	11
1000 kg	172	151	40	27	376	6 x 18	1	25	12.5





> Manual travel trolley CHD®

For loads from **250** kg to **10000** kg



CHD is equipped with a traversing beam with dedicated area for hook suspension.

- > The distance between flanges can be adjusted as required.
- > Travel is ensured by pushing or by hand wheel and chain.
- > The rollers are mounted on ball-bearings with removable axle.
- > The rollers are compatible with any type of monorail girder.



> Girder clamp PAP®

For loads from **1000** kg to **5000** kg

The PAP enables a lifting device to be hooked in fixed position from a girder, an attachment point for hoisting profiles, installation of mechanical limit switch (stop) at low cost... Its applications are limited only by your imagination!

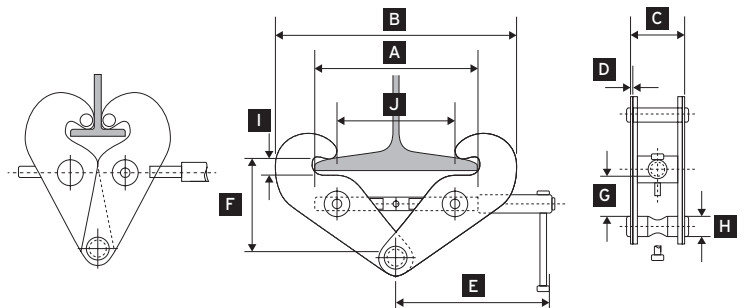

Load	I-beam width range (mm)	Net weight (kg)	A (mm)	B maxi (mm)	B mini (mm)	C (mm)	D (mm)	E (mm)	F maxi (mm)	F mini (mm)	G mini (mm)	H (mm)	I (mm)	J (mm)
1000	75-230	3.9	240	192	340	70	5	210	150	45	75	20	20	185
2000	75-230	5	240	192	340	78	6	210	150	45	90	20	20	185
3000	80-320	9.5	316	238	445	106	8	250	207	165	76	22	34	261
5000	90-310	11.3	306	248	455	114	10	250	210	167	76	28	34	251

STAGEMAKER®

Eurosystem ALU

For loads from **60** kg to **2000** kg

Overhead handling system made from aluminium hollow profile, specially dedicated for theater, arena or fix installation.

This new range of aluminium hollow profile offer possibility, from wide range of modular components portfolio, to simply built a crane or a monorail track in order to support an electric chain hoist. Both manual or electric trolley provide smooth and quiet travelling / crossing of the load.

From the high modularity concept of the system, all existing installation could be easily update or upgrade.



Profiles are available in black as well.

> Ergonomic

Light rails means users can very easily and effortlessly handle heavy and cumbersome loads.

> Accurate

Accuracy is ensured through high quality manufacture and smooth movements.

> Anti-corrosion

The aluminium profiles are externally and internally anodised.

> Economical

Reduce weight of supporting structure.

> Technological

The beam is the result of the latest innovations in cold extrusion and structure optimisation.

> Practical

The beam is compatible with all ITEM standard accessories.

> Lasting

Strong resistancy to wear and tear is the result of anodisation and the roller materials.

> Safety

The beam is guaranteed without welding.

> Silence

Operates silently due to the precise manufacture of the movement surface.

Eurosystem ALU in figures

Materials:

6063-T6 according to EN-AW standard

20 microns anodisation:

A6C0

Extrusion tolerance of beams according to standard:

EN 12020

Complies with applicable regulations according to standard:

FEM 9.771



4 sizes of beam

- > AL06, 6,5 kg/m, up to 320 kg.
- > AL08, 8 kg/m, up to 500 kg.
- > AL10, 10,6 kg/m, up to 2000 kg.
- > AL14, 14,5 kg/m, up to 2000 kg.

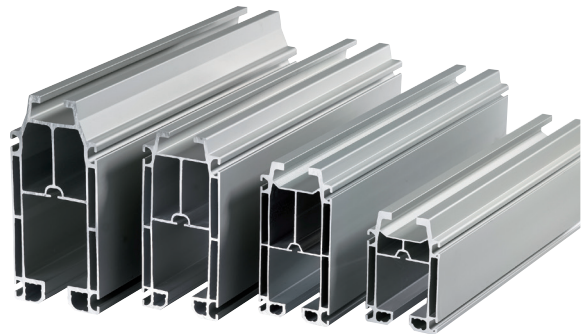

Reduced cost of supporting structures

- > 2 times lighter than its steel equivalent.
- > Easy to install and use.
- > Economical for lifting structures.

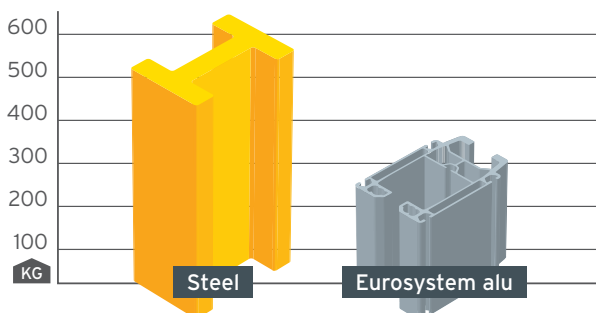

Better workstation ergonomics and increased productivity

Compared with steel rails, when manually moving loads, the movement coefficient of the trolley rollers is greatly reduced in order to minimise operator effort.

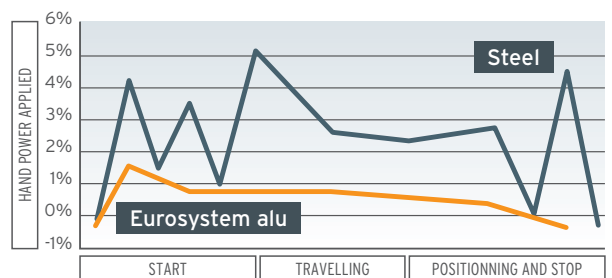

A **leader** in lifting equipment with a
large range of hoisting units from 60 to 250 000 kg.

Europe and USA **quality control** certified.

A customer service in more than **92** countries.



STAGEMAKER® worldwide

Distributors in Germany, Holland, Belgium, Italy, Argentina, Austria, Brazil, Chilli, Ireland, United Kingdom, Spain, Sweden, Norway, Finland, France, Portugal, Hungary, Poland, Russia, Denmark, China, Thailand, Indonesia, Malaysia, United States, Canada, Mexico, etc.

To locate distributor in your country, please consult: **www.stagemaker.com**

STAGEMAKER Europe

VERLINDE

2, boulevard de l'Industrie - B.P. 20059

28509 Vernouillet cedex - France

Téléphone : **+33 (0)2 37 38 95 95**

Fax : **+33 (0)2 37 38 95 99**

Internet : **www.stagemaker.com**

