

pewag winner inox stainless steel chain system G6 plus

Ideas and solutions in stainless steel



Now
available
with Duplex
material

(See pages
14,18,22 and 42)



pewag pump chains

All-round power packs.

- Safe and user-friendly lifting process of pumps and mixers
- Applies with all standards and regulations
- Equipped with ID-tag
- Possible chain audits by pewag
- Training courses for professional application:
academy.pewag.com

Detailed information
on pages 44-46.

Content

pewag winner inox stainless steel chain system G6 plus.

Businesses and end-users the world over need high-grade, stainless steel lifting equipment. pewag delivers quality that goes far beyond the standards of the market. We put our hearts and our minds into developing new products. Our love of detail really comes into its own when we are talking about stainless steel – and when it comes to technical expertise, we are certainly not rusty!

pewag group	
We are part of the pewag group	4-5
peTAG solution	
peTAG solution	6-7
pewag winner inox – lifting in G6 plus	
Benefits, information and working load limits	10-11
Reduction factors	12
Welded system	13-15
Assembled system	16-18
Order examples	19
Chain and accessories	
Lifting chain	22
Accessories	24-39
Pump chains in G6 plus	
PCWI Stainless pump chains	42-44
WOX-S Chain inox	45
S-PCWI service pump chain slings	46
User information	
General	48-49
Chain slings: Instructions on use and safety	50-51
Resistance table	52-53



Full Member

Technical changes and misprints are subject to alteration.

We are part of the **pewag group**

pewag lifting solutions is part of an internationally operating group of companies. Our success story goes back to the year 1479.

WHAT DRIVES US

Through our entrepreneurial spirit - shaped by the joy of innovation - we strive to offer the best solutions for the market. Today and in the future.

The high quality of our brands, products and services, as well as the passionate commitment of our employees are our most valuable assets to exceed customer expectations and to live up to our corporate responsibility towards people and environment.

LEADING TO EXCELLENCE



striving for excellence in **QUALITY**

The values of the pewag group brands are demonstrated by our first-class quality and continuous innovation. You can rely on us.



striving for excellence in **RESPONSIBILITY**

Our goal is CO₂ neutral production by 2030. We live sustainable and fair partnerships and an open way of working together. We take on social as well as environmental responsibility.



striving for excellence in **ENTREPRENEURSHIP**

Through the specific expertise of each individual and decentralized responsibilities, we ensure healthy growth and a sustainably successful future.



striving for excellence in **TECHNOLOGY**

We ensure our technological strength by striving for quality, continuous improvement and innovation of our products and production processes.

FROM AUSTRIA....



1479

First documentary mention of the forge

1787

Foundation of the chain forge in Kapfenberg

1803

Foundation of the location in Graz

1836

Establishment of an iron casting plant in Brückl

1912

Production of the first pewag snow chain

2009

pewag develops into an international group of companies

2021

Extensive investment in renewable energies. Goal: CO₂-neutral production by 2030

....ACROSS THE GLOBE

100+

Countries

50

Sales and other locations

45

Sales partners

16

Production sites

15+

Brands

5

Continents

IN A SUSTAINABLE WAY

Social Excellence

The corporate ethics of the pewag group are based on our clear commitment to universal human rights. As a globally active group of companies, we bear a social and corporate responsibility. This applies in particular to our employees. Their occupational safety and health protection are our top priority. We promote their personal and professional development and foster a culture of open, honest, non-discriminatory and team-oriented exchange based on transparent communication. We apply the same standards in our dealings with customers, suppliers and other business partners.



Environmental Excellence

We are committed to a careful and sustainable approach to the environment. This applies to all areas and activities of our group of companies. For us, it is a matter of course to use resources as efficiently as possible and to ensure this also in the future through new environmentally friendly and efficient processes. We are continuously working to optimize the durability and recyclability of our products. In this context, one of our core concerns is to continuously improve our energy efficiency and thus reduce energy consumption in the long term. The energy we use comes from renewable energy sources and is already partly generated by ourselves.

WHAT DEFINES US



Snow and forestry chains



Hoist and conveyor chains



Do-it-yourself



Engineering



Lifting solutions



Tire protection chains

Our Expertise.

Our international brands have an extensive and diverse range of products and services.

The portfolio ranges from traction chains for tires, tire protection chains for mining vehicles over a wide range of technical chains and innovative lifting solutions up to products for the do-it-yourself area as well as forming technology.

Our Network.

With over 50 locations on five continents, the pewag group forms a global platform of product specialists, partners and suppliers.

This community is strengthened by a large network of external experts from science, research and development and a wide range of brands and companies within the group.

Our Experience.

Based on centuries of experience, genuine craftsmanship and innovative technologies we process the highest quality materials with the claim to offer the best solutions on the market.

What unites us as people within the pewag group is the strong ambition for continuous development.

pewag chains together

The peTAG solution enables cross-company, flexible servicing and administration of a wide range of different objects.

peTAG solution

The intelligent solution for unambiguous object identification, data transfer without media breaks, easy servicing of objects, safe document archiving, efficient interaction with partner businesses and much more.

peTAG info

Smart, free-of-charge access to product-specific information via mobile web.



peTAG manager

Watch your PC and mobile devices work hand in hand with this adaptable, high-performance platform – in any work environment and while increasing data quality at the same time. Expensive add-on reading devices and manual data transfer are things of the past!



peTAG solution



peTAG solution Keyfacts



Intelligent software

User-specific adaptation of object data, testing processes and steps. Automates the creation, sending and archiving of test reports. Sophisticated authorisation concept.



Save time & money

Efficient documentation of work processes, thus simplified daily workflows. Data exchange without media breaks, fault-free data communication.



Mobile solution

Direct, location-independent data access (e.g. load capacity, safety information, latest test reports etc.) Smart servicing of objects via mobile app. Offline availability.



Linked-up partnerships

Straightforward exchange and efficient interaction between service providers, merchants and customers. Improved service and data quality. Increased satisfaction and loyalty.



Always up to date

Access to the latest product data and information, overview of all test data, documentation of test procedures. Traceability of object history.



pewag winner inox – lifting in G6 plus

Benefits and information

Content

Benefits information an working load limits	10-11
Reduction factors	12
Welded system	13
Possibilities of welded systems	14-15
Assembled system	16-17
Possibilities of assembled systems	18
Order examples	19





pewag winner inox G6 plus – weighty benefits.

Iron discipline in development and steely principles are the reasons why pewag is not satisfied with being among the global leaders in chain manufacturing. pewag works tirelessly to further enhance its competence in the field of stainless chains for the lifting of loads. This immense effort to stay ahead is also reflected in the grade 6 plus programme, with mechanical values based on a breaking tension of 630 N/mm². This means that we will be offering a complete product range with load capacities from 320 to 12,000 kg in the individual chain strand – quite an achievement!

Special features



Increase in carrying capacity of G6 plus by approx. 25 % with the same nominal diameter as the G5; therefore more lifting capacity with similar weight!

Enhanced load capacities

The working load limits listed are maximum values of the various sling types, stated according to the standard (uniform load) method of rating.

True to its name, pewag winner inox G6 plus offers several winning points:

- Eye hooks: Higher lifting capacity compared to G5, despite larger hook mouth and narrower passage on the hook body for better fit in eyelets and lifting points of the new, higher classifications where components become progressively smaller in relation to the load.
- pewag winner inox G6 plus allows the size to remain the same compared to G5 despite higher load capacity.
- Master links fit well into large crane hooks.
- pewag master links are capable of even more: Thanks to their inside width, they may be fitted into crane hooks even for small chain dimensions (from 320 kg).
- The programme extension makes for a load capacity increase to 12 tonnes and for pump chains from 320 up to a remarkable 12,000 kg!

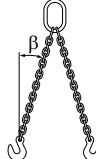
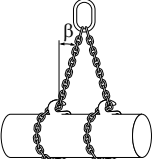
Safety factor 4		I-leg chains		II-leg chains				
1:4								
	Angle of inclination	-	-	0°-45°	45°-60°	0°-45°	45°-60°	
Load factor	1	0.8	1.4	1	1.12	0.8		
Code	d	Load capacity [kg]						
WOX 4-6	4	400	320	560	400	450	320	
WOX 4-5	4	320	256	450	320	355	256	
WOX 5-6	5	630	500	850	630	700	500	
WOX 5-5	5	500	400	700	500	560	400	
WOX 6-6	6	900	720	1,250	900	1,000	720	
WOX 6-5	6	750	600	1,000	750	800	600	
WOX 7-6	7	1,250	1,000	1,750	1,250	1,400	1,000	
WOX 7-5	7	1,000	800	1,400	1,000	1,120	800	
WOX 8-6	8	1,600	1,280	2,200	1,600	1,800	1,280	
WOX 8-5	8	1,250	1,000	1,700	1,250	1,400	1,000	
WOX 10-6	10	2,500	2,000	3,500	2,500	2,800	2,000	
WOX 10-5	10	2,000	1,600	2,800	2,000	2,240	1,600	
WOX 13-6	13	4,250	3,400	5,950	4,250	4,750	3,400	
WOX 13-5	13	3,200	2,560	4,500	3,200	3,550	2,560	
WOX 16-6	16	6,300	5,040	8,800	6,300	7,050	5,040	
WOX 16-5	16	5,000	4,000	7,100	5,000	5,600	4,000	
WOX 20-5	20	8,000	6,400	11,200	8,000	-	-	
WOX 26-4+	26	12,000	9,600	-	-	-	-	

Stainless steel lifting chains and components in G6 plus – we take reliability to a new level!

Absolute reliability when it comes to usage is our top priority also for those elements that are used as links in a long chain of quality products.

Stainless steel lifting chains and components in G6 plus feature a **stress at working load limit** of 160 N/mm², **breaking stress** of 630 N/mm² and a minimum breaking elongation of at least 20 %.

The following materials are used: 1.4571 (AISI 316 Ti), 1.4404 (AISI 316 L) and 1.4462 (AISI F51). The chain **surface** is brightly polished, the components are pickled and blasted.



III- + IV- leg chains		Endless chain sling	Single lifting sling		Double lifting sling		U-Shape
0°-45°	45°-60°	-	0°-45°	45°-60°	0°-45°	45°-60°	-
2.1	1.5	1.6	1.4	1	2.1	1.5	2
Load capacity [kg]							
840	600	640	560	400	840	600	800
670	475	512	450	320	670	475	640
1,300	940	1,000	850	630	1,300	940	1,260
1,050	750	800	700	500	1,050	750	1,000
1,850	1,350	1,400	1,250	900	1,850	1,350	1,800
1,600	1,120	1,200	1,000	750	1,600	1,120	1,500
2,600	1,850	2,000	1,750	1,250	2,600	1,850	2,500
2,100	1,500	1,600	1,400	1,000	2,100	1,500	2,500
3,350	2,400	2,500	2,220	1,600	3,350	2,400	3,200
2,650	1,800	2,000	1,700	1,250	2,650	1,800	2,500
5,250	3,750	4,000	3,500	2,500	5,250	3,750	5,000
4,250	3,000	3,200	2,800	2,000	4,250	3,000	4,000
8,900	6,350	6,800	5,950	4,250	8,900	6,350	8,500
6,700	4,750	5,120	4,500	3,200	6,700	4,750	6,400
13,200	9,400	10,000	8,800	6,300	13,200	9,400	12,600
10,000	7,500	8,000	7,100	5,000	10,000	7,500	10,000
-	-	12,800	11,200	8,000	-	-	16,000
-	-	19,200	-	-	-	-	24,000

Reduction factors – all you need to know.

Even top-quality chains will lose some of their load capacity when exposed to high temperatures, asymmetrical load distribution, edge loading, impact/shock loads or other severe conditions. The tables, including the technical data, list the maximum load capacities that must be reduced by the load factors if such conditions apply. Please also refer to the user manual.

If chains are wound around support arms or other round-shaped loads, the diameter should be at least 3x the chain pitch. For smaller diameters, the lifting capacity of the chains must be reduced by 50 %.

The winner inox chain system G6 plus shall not be used with temperatures over 350 °C. If you consider using the system with higher temperatures, please contact our competent service team for advice! Under certain conditions the operation temperature can apply 700 °C. Therefore you must contact the pewag service team for advice!

Temperature	-40 °C – 350 °C	-40 °C – 350 °C	above 350 °C
Load factor	1	1	not permissible; please contact our technical service.
Asymmetric load distribution	The WLL has to be reduced by at least 1 leg. In case of doubt only consider 1 leg as load-bearing.		
Edge load	R = larger than 2x d* 	R = larger than d* 	R = smaller than d* 
Load factor	1	0.7	0.5
Shock	slight shocks	medium shocks	strong shocks
Load factor	1	0.7	not permissible

* d = thickness of the material



Welded system

Special areas of application require special products.

In this day and age, manufacturers need high-impact arguments in their favour as well as high-impact products if they want to establish themselves on the market long-term. For decades, pewag has successfully adapted to changing user demands and requirements. Our nerves of steel definitely help us come up with innovative developments on an ongoing basis, which we then present to you on a silver platter (or rather, a stainless steel one)!

One of pewag's core competencies is their specialisation in the professional welding of chains and components. Our history in this field goes back an impressive 500 years – that is how long we have been manufacturing chains, with expertise and know-how being handed down from generation to generation. A competitive advantage that we are holding on to with an iron fist.

All in one piece

When welding round link/profile chains and oval links, no outside material is used, making for a seamless finish. The chaining wires are welded using electric energy and mechanical upsetting forces to create a homogenous unit that withstands any load test. Full penetration (100 %) of welding locations prevents hollows and cracks inside the seams, thus ruling out water and chemical accumulations or residues.

This flawless quality and perfectly smooth surface make pewag chains particularly suited for hygiene applications, as any dirt or impurities may be removed quickly and easily.

If a chain sling is subject to strong vibrations, a welded system offers maximum safety and a long lifespan. Welded chain constructions under certain conditions can be used in a wide range of applications:





- Water, wastewater and pump technology.
- Chemical and oil industry.
- Environmental technology and renewable energy.
- Food, slaughter, hygiene and fishing industry.
- Power plant and plant engineering and construction (resistant even at high temperatures).
- Surface treatments.
- Navy and military use.
- Sports and leisure industry.



The stamp on the chain shows the seal that is synonymous with high quality.

Perfection, piece by piece: pewag winner inox stainless steel chain slings and endless chains in the welded system.

Below, you will find an overview of different combinations of stainless steel chain slings and components as well as endless chains. Of course, there are many more options available. We are also glad to supply customised variations upon request. The pewag customer service team is here to help!

	Diameter d [mm]	WLL I-leg [kg]	WLL 0–45° [kg]	WLL 45–60° [kg]	*Top fitting	Shortener	**Possible end fittings			
					Master link /-assembly AWI/VWI	Chain shortener VLWI	Eye sling hook HSWI	Master link AWI	Transition link BWI	Shackle SSWI
I-leg chain sling										
	4	400	-	-	AWI 8-6	-	-	AWI 8-6	BWI 5-6	SSWI 0.63 t-S/-W
	5	630	-	-	AWI 10-6	VLWI 5/6-6	HSWI 5/6-6	AWI 10-6	BWI 7-6	SSWI 0.63 t-S/-W
	6	900	-	-	AWI 13-6	VLWI 5/6-6	HSWI 5/6-6	AWI 13-6	BWI 7-6	SSWI 0.9 t-S
	7	1,250	-	-	AWI 13-6	VLWI 7/8-6	HSWI 7/8-6	AWI 13-6	BWI 9-6	SSWI 1.6 t-S
	8 ¹⁾	1,600	-	-	AWI 13-6	VLWI 7/8-6	HSWI 7/8-6	AWI 13-6	BWI 10-6	SSWI 1.6 t-S
	10 ¹⁾	2,500	-	-	AWI 16-6	VLWI 10-6	HSWI 10-6	AWI 16-6	BWI 13-6	SSWI 2.5 t-S
	13	4,250	-	-	AWI 22-6	VLWI 13-6	HSWI 13-6	AWI 22-6	BWI 16-6	SSWI 4.25 t-S
	16	6,300	-	-	AWI 22-6	VLWI 16-6	HSWI 16-6	AWI 22-6	BWI 20-6	SSWI 6.3 t-S
20	8,000	-	-	AWI 26-6	-	-	AWI 26-6	BWI 22-6	SSWI 26-C	
26	12,000	-	-	AWI 45	-	-	AWI 45	BWI 32-6	SSWI 26-C	
II-leg chain sling										
	4	-	560	400	AWI 8-6	-	-	AWI 8-6	BWI 5-6	SSWI 0.63 t-S/-W
	5	-	850	630	AWI 10-6	VLWI 5/6-6	HSWI 5/6-6	AWI 10-6	BWI 7-6	SSWI 0.63 t-S/-W
	6	-	1,250	900	AWI 13-6	VLWI 5/6-6	HSWI 5/6-6	AWI 13-6	BWI 7-6	SSWI 0.9 t-S
	7	-	1,750	1,250	AWI 16-6	VLWI 7/8-6	HSWI 7/8-6	AWI 13-6	BWI 9-6	SSWI 1.6 t-S
	8 ¹⁾	-	2,200	1,600	AWI 16-6	VLWI 7/8-6	HSWI 7/8-6	AWI 13-6	BWI 10-6	SSWI 1.6 t-S
	10 ¹⁾	-	3,500	2,500	AWI 18-6	VLWI 10-6	HSWI 10-6	AWI 16-6	BWI 13-6	SSWI 2.5 t-S
	13	-	5,950	4,250	AWI 22-6	VLWI 13-6	HSWI 13-6	AWI 22-6	BWI 16-6	SSWI 4.25 t-S
	16	-	8,800	6,300	AWI 26-6	VLWI 16-6	HSWI 16-6	AWI 22-6	BWI 20-6	SSWI 6.3 t-S
20	-	11,200	8,000	AWI 32-6	-	-	AWI 26-6	BWI 22-6	SSWI 26-C	
III-leg chain sling										
	4	-	840	600	VWI 4-6	-	-	AWI 8-6	BWI 5-6	SSWI 0.63 t-S/-W
	5	-	1,300	940	VWI 5-6	VLWI 5/6-6	HSWI 5/6-6	AWI 10-6	BWI 7-6	SSWI 0.63 t-S/-W
	6	-	1,850	1,350	VWI 6/7-6	VLWI 5/6-6	HSWI 5/6-6	AWI 13-6	BWI 7-6	SSWI 0.9 t-S
	7	-	2,600	1,850	VWI 6/7-6	VLWI 7/8-6	HSWI 7/8-6	AWI 13-6	BWI 9-6	SSWI 1.6 t-S
	8 ¹⁾	-	3,350	2,400	VWI 8-6	VLWI 7/8-6	HSWI 7/8-6	AWI 13-6	BWI 10-6	SSWI 1.6 t-S
	10 ¹⁾	-	5,250	3,750	VWI 10-6	VLWI 10-6	HSWI 10-6	AWI 16-6	BWI 13-6	SSWI 2.5 t-S
	13	-	8,900	6,350	VWI 13-6	VLWI 13-6	HSWI 13-6	AWI 22-6	BWI 16-6	SSWI 4.25 t-S
	16	-	13,200	9,400	VWI 16-6	VLWI 16-6	HSWI 16-6	AWI 22-6	BWI 20-6	SSWI 6.3 t-S
IV-leg chain sling										
	4	-	840	600	VWI 4-6	-	-	AWI 8-6	BWI 5-6	SSWI 0.63 t-S/-W
	5	-	1,300	940	VWI 5-6	VLWI 5/6-6	HSWI 5/6-6	AWI 10-6	BWI 7-6	SSWI 0.63 t-S/-W
	6	-	1,850	1,350	VWI 6/7-6	VLWI 5/6-6	HSWI 5/6-6	AWI 13-6	BWI 7-6	SSWI 0.9 t-S
	7	-	2,600	1,850	VWI 6/7-6	VLWI 7/8-6	HSWI 7/8-6	AWI 13-6	BWI 9-6	SSWI 1.6 t-S
	8 ¹⁾	-	3,350	2,400	VWI 8-6	VLWI 7/8-6	HSWI 7/8-6	AWI 13-6	BWI 10-6	SSWI 1.6 t-S
	10 ¹⁾	-	5,250	3,750	VWI 10-6	VLWI 10-6	HSWI 10-6	AWI 16-6	BWI 13-6	SSWI 2.5 t-S
	13	-	8,900	6,350	VWI 13-6	VLWI 13-6	HSWI 13-6	AWI 22-6	BWI 16-6	SSWI 4.25 t-S
	16	-	13,200	9,400	VWI 16-6	VLWI 16-6	HSWI 16-6	AWI 22-6	BWI 20-6	SSWI 6.3 t-S

L = Effective working length according customer specification

Now available with Duplex material

¹⁾ Available on request in duplex material 1.4462 (AISI F51 / AISI 318 LN), except VLWI and SSWI

SWI Endless chain	Code	Diameter d [mm]	WLL laced [kg]
-------------------	------	-----------------	----------------

These stainless steel endless chains are electrically welded for an extra-clean finish, with the same link dimensions as the chain, welded and 100 % proof tested.



SWI 4	4	640
SWI 5	5	1,000
SWI 6	6	1,400
SWI 7	7	2,000
SWI 8	8	2,500
SWI 10	10	4,000
SWI 13	13	6,800
SWI 16	16	10,000

Order example: WOX 7-6 mm SWI 4,000 endless chain with a circumferential length of 4 m.

As part of the comprehensive pewag service, all chain slings and endless chains in the welded system come with an identification tag and test certificate.



Assembled system

Versatile like no other, sophisticated and with multiple combining options.

The possibility to assemble stainless steel chains and components by competent persons according to requirements, is the perfect complement to the welded chain system within the pewag winner inox G6 plus product range. The components are absolutely practical, far-reaching and variable. Consequently, individual components may be combined with products from other suppliers, if the quality, grade and tolerance levels are similar to pewag standards.

Seamless linking

For the perfect combination there is a joker you can rely on: The CWI Connex connecting link, its multi-functionality really comes into its own in terms of possible combinations and flexibility. Whether Connex links are used in combination with stainless steel chains or wire ropes, eye hooks and master links or Connex links – they are unsurpassed in terms of user-friendliness and the unbeatable pewag quality.

pewag winner inox is superior to conventional lifting slings: pewag winner inox can be used in dissimilar corrosive mediums as well as at elevated temperatures – in certain circumstances, even up to a maximum of +700 °C. Truly unique features that will surely melt away any remaining doubts. This is a highly sophisticated system whose chains and components are manufactured on the basis of high-grade steels Mat. 1.4571 (AISI 316 Ti) and 1.4404 (AISI 316 L) as well as 1.4462 (AISI F51). Due to a special manufacturing method, these only contain a limited proportion of carbon.

We test the best...

... because that's who we are: The pewag quality management system (ISO 9001) and ongoing controls during the manufacturing process ensure the highest possible level of safety and an extremely long lifespan – correct usage provided, of course. And another thing – pewag never stands still. The pewag winner inox range continues to develop and to adapt to future requirements, so watch this space!



pewag winner inox: Never for the scrap heap!

The CWI Connex connecting link – linking chains and components.

The CWI Connex is not just any connecting link. Indeed, the arguments in its favour are as incorruptible as... well, as steel:

- No special requirements for connecting are needed, for instance flat sections or similar.
- Other lifting accessories such as hooks, master links, shortenings etc. can be just as easily integrated.
- The two-part design makes for easy connection with eyes or openings or mounting over shafts and tubes.
- Easy retrofitting or dismantling.
- Due to the large radii of the system, Connex provides plenty of space during the linking process in a wide range of applications.
- CWI Connex is also known as the “problem solver” – there are hardly any limits when it comes to combination with other elements.

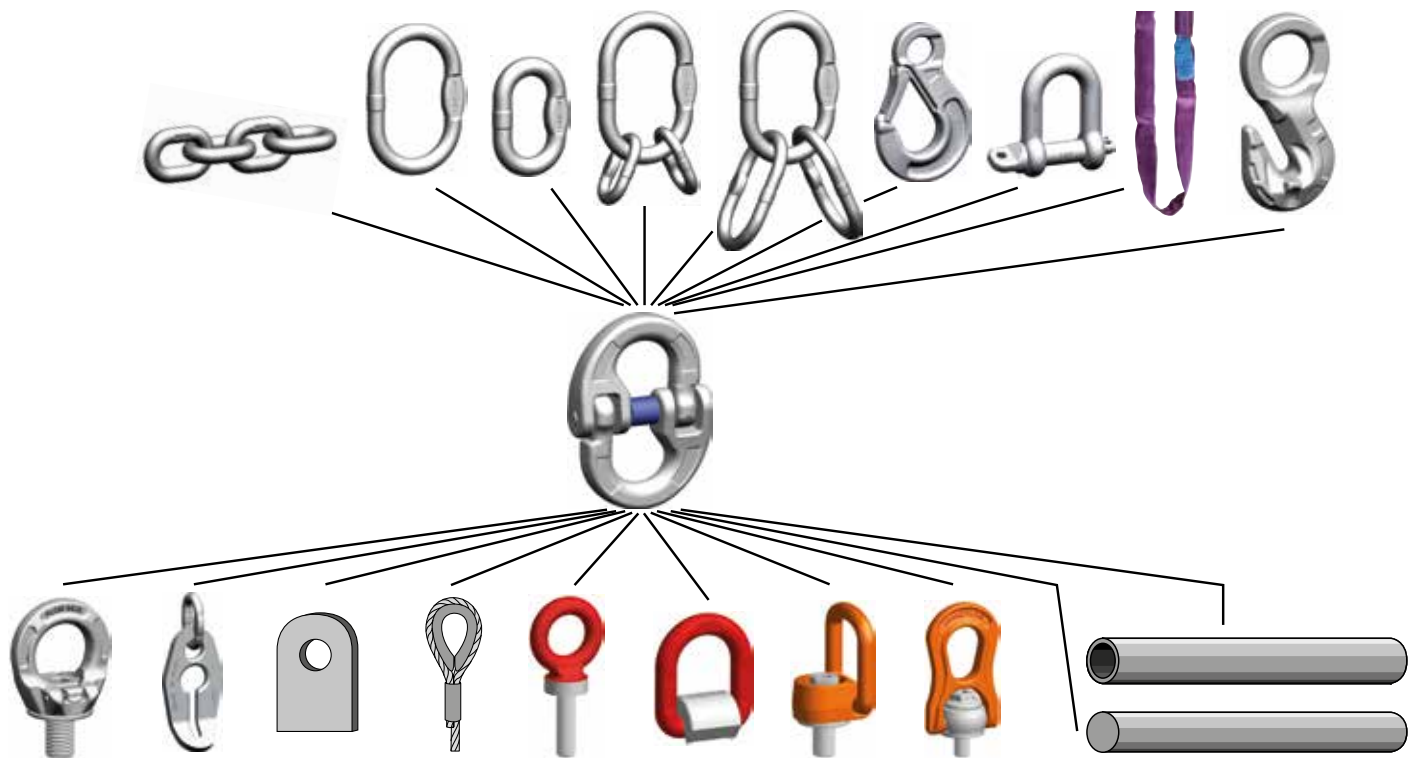

Extremely versatile when it comes to possible combinations: The trademark of the CWI Connex connecting link.

It is all about the combination within the assembled inox G6 plus system.

Below, you will find an overview of different combinations of components within the assembled system. The possibilities are nearly endless! Of course, there are many more options available. We are also happy to supply customised versions upon request. The pewag customer service team is here to help!

	Diameter d [mm]	WLL I-leg [kg]	WLL 0-45° [kg]	WLL 45-60° [kg]	*Top fitting	Shortener	**Possible end fittings			
					Master link /-assembly AWI/VWI	Chain shortener VLWI	Eye sling hook HSWI	Master link AWI	Transition link BWI	Shackle SSWI
I-leg chain sling										
	5	630	-	-	AWI 10-6	VLWI 5/6-6	HSWI 5/6-6	AWI 10-6	BWI 7-6	SSWI 0.63 t-S/-W
	6	900	-	-	AWI 13-6	VLWI 5/6-6	HSWI 5/6-6	AWI 13-6	BWI 7-6	SSWI 0.9 t-S
	7	1,250	-	-	AWI 13-6	VLWI 7/8-6	HSWI 7/8-6	AWI 13-6	BWI 9-6	SSWI 1.6 t-S
	8 ¹⁾	1,600	-	-	AWI 13-6	VLWI 7/8-6	HSWI 7/8-6	AWI 13-6	BWI 10-6	SSWI 1.6 t-S
	10 ¹⁾	2,500	-	-	AWI 16-6	VLWI 10-6	HSWI 10-6	AWI 16-6	BWI 13-6	SSWI 2.5 t-S
	13	4,250	-	-	AWI 22-6	VLWI 13-6	HSWI 13-6	AWI 22-6	BWI 16-6	SSWI 4.25 t-S
	16	6,300	-	-	AWI 22-6	VLWI 16-6	HSWI 16-6	AWI 22-6	BWI 20-6	SSWI 6.3 t-S

L = Effective working length according customer specification

II-leg chain sling

	5	-	850	630	AWI 10-6	VLWI 5/6-6	HSWI 5/6-6	AWI 10-6	BWI 7-6	SSWI 0.63 t-S/-W
	6	-	1,250	900	AWI 13-6	VLWI 5/6-6	HSWI 5/6-6	AWI 13-6	BWI 7-6	SSWI 0.9 t-S
	7	-	1,750	1,250	AWI 16-6	VLWI 7/8-6	HSWI 7/8-6	AWI 13-6	BWI 9-6	SSWI 1.6 t-S
	8 ¹⁾	-	2,200	1,600	AWI 16-6	VLWI 7/8-6	HSWI 7/8-6	AWI 13-6	BWI 10-6	SSWI 1.6 t-S
	10 ¹⁾	-	3,500	2,500	AWI 18-6	VLWI 10-6	HSWI 10-6	AWI 16-6	BWI 13-6	SSWI 2.5 t-S
	13	-	5,950	4,250	AWI 22-6	VLWI 13-6	HSWI 13-6	AWI 22-6	BWI 16-6	SSWI 4.25 t-S
	16	-	8,800	6,300	AWI 26-6	VLWI 16-6	HSWI 16-6	AWI 22-6	BWI 20-6	SSWI 6.3 t-S

L = Effective working length according customer specification

III-leg chain sling

	5	-	1,300	940	VWI 5-6	VLWI 5/6-6	HSWI 5/6-6	AWI 10-6	BWI 7-6	SSWI 0.63 t-S/-W
	6	-	1,850	1,350	VWI 6/7-6	VLWI 5/6-6	HSWI 5/6-6	AWI 13-6	BWI 7-6	SSWI 0.9 t-S
	7	-	2,600	1,850	VWI 6/7-6	VLWI 7/8-6	HSWI 7/8-6	AWI 13-6	BWI 9-6	SSWI 1.6 t-S
	8 ¹⁾	-	3,350	2,400	VWI 8-6	VLWI 7/8-6	HSWI 7/8-6	AWI 13-6	BWI 10-6	SSWI 1.6 t-S
	10 ¹⁾	-	5,250	3,750	VWI 10-6	VLWI 10-6	HSWI 10-6	AWI 16-6	BWI 13-6	SSWI 2.5 t-S
	13	-	8,900	6,350	VWI 13-6	VLWI 13-6	HSWI 13-6	AWI 22-6	BWI 16-6	SSWI 4.25 t-S
	16	-	13,200	9,400	VWI 16-6	VLWI 16-6	HSWI 16-6	AWI 22-6	BWI 20-6	SSWI 6.3 t-S

L = Effective working length according customer specification

IV-leg chain sling

	5	-	1,300	940	VWI 5-6	VLWI 5/6-6	HSWI 5/6-6	AWI 10-6	BWI 7-6	SSWI 0.63 t-S/-W
	6	-	1,850	1,350	VWI 6/7-6	VLWI 5/6-6	HSWI 5/6-6	AWI 13-6	BWI 7-6	SSWI 0.9 t-S
	7	-	2,600	1,850	VWI 6/7-6	VLWI 7/8-6	HSWI 7/8-6	AWI 13-6	BWI 9-6	SSWI 1.6 t-S
	8 ¹⁾	-	3,350	2,400	VWI 8-6	VLWI 7/8-6	HSWI 7/8-6	AWI 13-6	BWI 10-6	SSWI 1.6 t-S
	10 ¹⁾	-	5,250	3,750	VWI 10-6	VLWI 10-6	HSWI 10-6	AWI 16-6	BWI 13-6	SSWI 2.5 t-S
	13	-	8,900	6,350	VWI 13-6	VLWI 13-6	HSWI 13-6	AWI 22-6	BWI 16-6	SSWI 4.25 t-S
	16	-	13,200	9,400	VWI 16-6	VLWI 16-6	HSWI 16-6	AWI 22-6	BWI 20-6	SSWI 6.3 t-S

L = Effective working length according customer specification

Now available with Duplex material

¹⁾ Available on request in duplex material 1.4462 (AISI F51 / AISI 318 LN), except VLWI and SSWI

Sample order for pewag winner inox.

Ordering pewag winner inox G6 plus chain slings is easy. The addition „Connex“ within the order text describes an assembled chain sling whereas otherwise the welded systems is meant. The usual tolerance of the length „L“ is +2 chain pitches. The pewag team is happy to advise you and looks forward to your order.

Whatch out: To ensure a safe application of chain slings, you have to maintain them on a regular basis. Again, the pewag team is at your side with help and advice – just ask for it.

Connex System:

WOX 10-6 II AWI - HSWI 3500 Connex

Nominal diameter	Number of legs	Master link	End hook	Length L [mm]	Connex mounted
------------------	----------------	-------------	----------	---------------	----------------

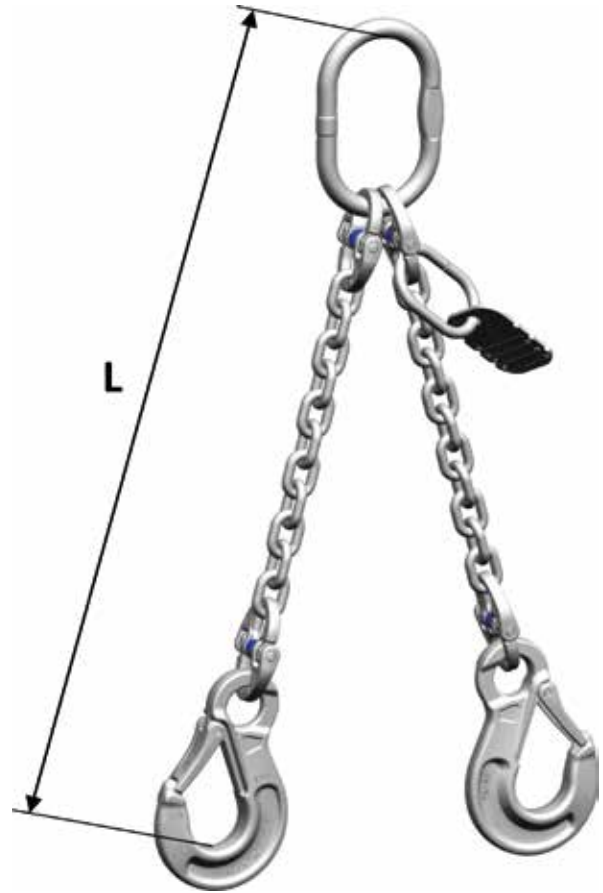

Welded system:

WOX 10-6 II AWI - HSWI 3500

Nominal diameter	Number of legs	Master link	End hook	Length L [mm]
------------------	----------------	-------------	----------	---------------

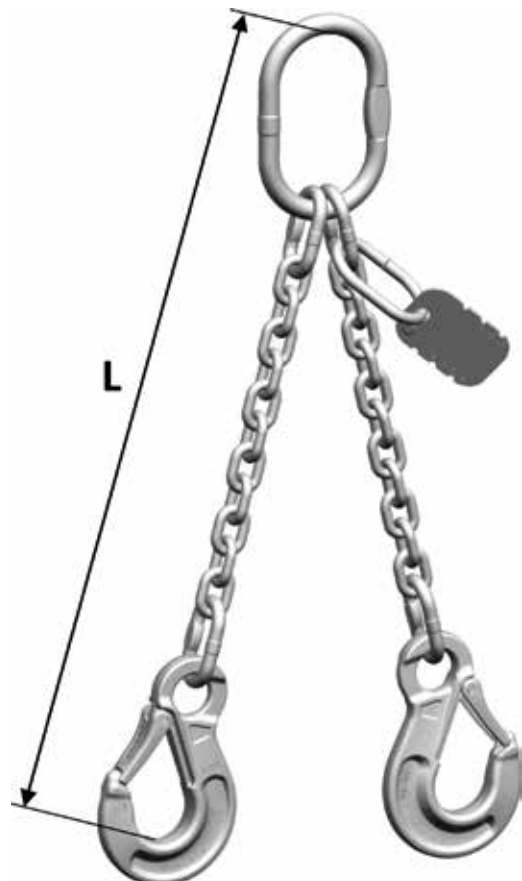

Chain and accessories

Product overview

Content

WOX Chain	22
AWI Master link	24
BWI Transition link	25
VWI Master link assembly	26
VAWI Special master link assembly for wire ropes	27
CWI Connex connecting link	28
HWSI Eye sling hook	29
PWI Grab hook	30
VLWI Chain shortener	31
LCWI Loop connector	32
SSWI Safety shackle	33
PLGWI Eyebold	34-36
CBHWI Bolts and safety bush	37
SFGWI Safety catch	38
IDWOX Identification tag	39





pewag[®] WOX Chain inox

Clean, tidy and hard-working.

This stainless steel lifting chain is made from high-grade stainless steel, with a load capacity that is 25 % higher than that of G5 lifting chains. The chains are 100 % proof tested and have a Working Load Limit of up to 12.000 kg. The chain is electrically welded for an extra-clean finish, stamped and with a higher resistance to acids and caustics than the standard lifting chains G8, G10 and G12. The chain is guaranteed to be compatible with the Connex CWI links, with dimensions that are similar to DIN 5687-1 and EN 818-2. The stamp makes the chains clearly identifiable.

The WOX chain is particularly suitable for use in water and for wastewater applications. It can also be used in connection with chemicals and food products; however, restrictions will apply. Usage is possible up to a temperature of 700 °C, for which special criteria apply for the reduction of the load capacity. We will be happy to advise you.



WOX Chain inox	Code	Nominal diameter dn [mm]	Standard delivery length [m]	Pitch t [mm]	Inside width b1 min. [mm]	Outside width b2 max. [mm]	Load capacity [kg]	Breaking force [kN]	Weight [kg/m]
	WOX 4-6	4	50	12	5.80	14.80	400	16	0.40
	WOX 5-6	5	50	15.10	7.50	18.50	630	25	0.61
	WOX 6-6	6	50	18	8	21.50	900	37.50	0.88
	WOX 7-6	7	50	21	9.50	25.20	1,250	50	1.19
	WOX 8-6	8	50	24	10.80	28.60	1,600	63	1.53
	WOX 10-6	10	50	30	13.50	36	2,500	100	2.40
	WOX 13-6	13	25	39	17.50	46.80	4,250	170	4.05
	WOX 16-6	16	25	48	21.50	57.60	6,300	250	6.00
	WOX 20-5	20	-	60	27	72	8,000	314	9.29
	WOX 26-4+	26	-	78	35	93.60	12,000	471	16.20

Material: 1.4404 (AISI 316 L) for WOX G6 and WOX G5
Material: 1.4571 (AISI 316 Ti) for WOX G4+

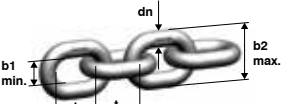
WOX Duplex chain inox	Code	Nominal diameter dn [mm]	Standard delivery length [m]	Pitch t [mm]	Inside width b1 min. [mm]	Outside width b2 max. [mm]	Load capacity [kg]	Breaking force [kN]	Weight [kg/m]
	WOX 8-6 D	8	50	24	10.80	28.60	1,600	63	1.53
	WOX 10-6 D	10	50	30	13.50	36	2,500	100	2.40

Material: 1.4462 (AISI F51 / AISI 318 LN) for WOX G6-D

Now available with Duplex material

The duplex material 1.4462 is above all resistant to sea water and is preferably used in the water, wastewater, marine sector. For more detailed information, please refer to the table on page 55 or contact our technical service.

pewag academy



Intermedial courses

Sustainable learning through intermediality of teaching material and didactic methods



Anytime, anywhere

Maximum flexibility in learning with access to all information on the online learning platform



ISO certified

High quality through ISO certification for learning services in non-formal education and training

Knowledge for you

Product and technology training, e-learning, blended learning

Learn about optimum use of pewag products from the first commissioning to ongoing use and maintenance, as well as about the technology applied and how it influences the product performance, quality and durability.



academy.pewag.com



pewag group

LEADING TO EXCELLENCE



pewag AWI Master link

Doubles up as a dependable end link.

High-grade stainless steel yields a result that outshines the rest: This stainless master link is electrically welded for a clean finish, stamped and suitable for both I- and II-leg assemblies and wire rope slings (similar to DIN 3088- 1989). The master link may also be used in VWI four-leg assemblies and as an end link. Its dimensions are similar to DIN 5688-1 and it is tested at 100 % of its load capacity.

A particular bonus is the higher resistance to acids and caustics compared to the standard loading rings G8, G10 and G12. The stamp makes the master link clearly identifiable. The master link also bears the CE-mark.

The AWI Master link is particularly suited for use in water and wastewater applications. It can also be used in connection with chemicals and food products; however, restrictions will apply.



AWI Master link

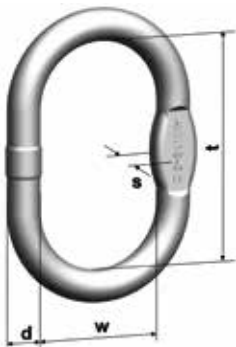

Code	Load capacity 0°-45° [kg]	Fits on single hook acc. DIN 15401 no.	Fits on double hook acc. DIN 15402 no.	For 1-leg slings	For 2-leg slings
AWI 8-6	560	0.50	-	4	4
AWI 10-6	850	1.60	2.50	5	5
AWI 13-6	1,600	2.50	4	6/7/8	6
AWI 16-6	2,600	2.50	4	10	7/8
AWI 18-6	3,500	5	6	-	10
AWI 22-6	6,300	6	8	13/16	13
AWI 26-6	8,900	8	10	20	16
AWI 32-6	13,200	10	12	-	20
AWI 36-6	14,700	16	20	-	-
AWI 45	12,000	25	32	26	-

Code	d [mm]	t [mm]	w [mm]	s [mm]	Weight [kg/pc.]
AWI 8-6	8	60	35	-	0.08
AWI 10-6	10	80	50	-	0.16
AWI 13-6	13	110	60	10	0.34
AWI 16-6	16	110	60	14	0.53
AWI 18-6	18	135	75	14	0.83
AWI 22-6	23	160	90	17	1.55
AWI 26-6	27	180	100	20	2.46
AWI 32-6	32	200	110	26	3.86
AWI 36-6	36	260	140	29	6.22
AWI 45	45	340	180	-	12.82

Custom made, also with flattening available.

Material: 1.4404 (ASI 316 L) from AWI 8-6 to AWI 10-6 and from AWI 45

Material: 1.4462 (ASI F51 / AISI 318 LN) from AWI 13-6 to AWI 36-6

pewag BWI Transition link

Electrically welded for an extra-clean finish.

A higher resistance to acids and caustics compared to the standard transition links G8, G10 and G12 is just one of the many benefits that make this stamped transition link truly remarkable. The use of high-grade stainless steel also ensures that this electrically welded transition and securing link will never rust.

The stamp and the CE-mark ensure that the product is clearly identifiable. The transition link is part of welded assemblies, may also be used as an end link and is 100 % proof tested. Its dimensions are similar to DIN 5688-1.

The outstanding quality of this transition link is also reflected in its wide range of possible applications: It may be used as a connecting link for assembling I- to IV-leg assemblies in welded systems as well as an end link. In addition, it is ideally suited for use in water and wastewater applications and can also be used in connection with chemicals and food products; however, restrictions will apply.



BWI Transition link	Code	Load capacity 0°-45° [kg]	d [mm]	t [mm]	w [mm]	s [mm]	Weight [kg/pc.]	For 1-leg slings	For 2-leg slings
	BWI 7-6	900	7	36	16	-	0.04	5/6	5/6
	BWI 9-6	1,250	9	44	20	-	0.07	7	7
	BWI 10-6	1,600	10	44	20	-	0.09	8	8
	BWI 13-6	2,500	13	54	25	10	0.18	10	10
	BWI 16-6	4,250	16	70	34	14	0.35	13	13
	BWI 20-6	6,300	20	85	40	16	0.67	16	16
	BWI 22-6	8,000	23	115	50	17	1.16	20	-
	BWI 26-6	10,070	27	140	65	20	1.92	-	-
	BWI 32-6	12,000	32	150	70	26	3.18	26	-

Custom made, also with flattening available.

Material: 1.4404 (AISI 316 L) from BWI 7-6 to BWI 9-6

Material: 1.4462 (AISI F51 / AISI 318 LN) from BWI 10-6 to BWI 32-6

pewag VWI Master link assembly

Consistent performance.

This stainless steel chain sling is electrically welded for a clean finish, stamped and ideally suited for assembling III- and IV-leg chain slings in welded or assembled systems. The dimensions are similar to DIN 5688-1.

The VWI Master link assembly is 100 % proof tested. It is made from high-grade stainless steel with a higher resistance to acids and caustics than the standard four-leg chain slings G8, G10 and G12.

It is ideally suited for use in water and wastewater applications and can also be used in connection with chemicals and food products; however, restrictions will apply. The stamp and the CE-mark ensure that the product is clearly identifiable.

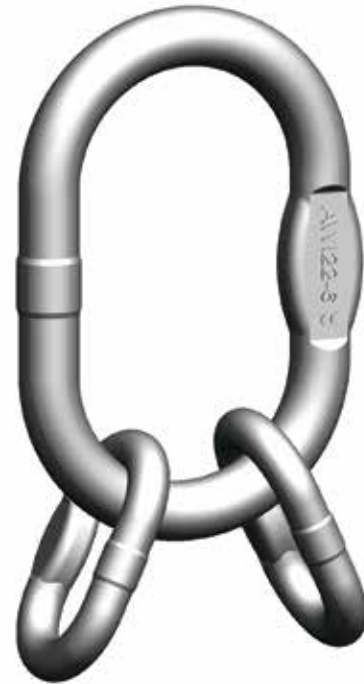

VWI Master link assembly	Code	Consisting of	Fits on single hook acc. DIN 15401 no.	Fits on double hook acc. DIN 15402 no.	Load capacity 0°-45° [kg]	Weight [kg/pc.]
	VWI 4-6	AWI 10-6 + 2 BWI 9-6	1.60	2.50	840	0.28
	VWI 5-6	AWI 13-6 + 2 BWI 10-6	2.50	4	1,300	0.52
	VWI 6/7-6	AWI 16-6 + 2 BWI 13-6	2.50	4	2,600	0.91
	VWI 8-6	AWI 18-6 + 2 BWI 16-6	5	6	3,350	1.64
	VWI 10-6	AWI 22-6 + 2 BWI 20-6	6	8	5,250	3.02
	VWI 13-6	AWI 26-6 + 2 BWI 22-6	8	10	8,900	4.78
	VWI 16-6	AWI 32-6 + 2 BWI 26-6	10	12	13,200	7.98

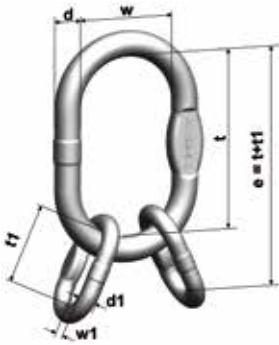

Code	e [mm]	d [mm]	t [mm]	w [mm]	d1 [mm]	t1 [mm]	w1 [mm]
VWI 4-6	124	10	80	50	9	44	20
VWI 5-6	154	13	110	60	10	44	20
VWI 6/7-6	164	16	110	60	13	54	25
VWI 8-6	205	18	135	75	16	70	34
VWI 10-6	245	23	160	90	20	85	40
VWI 13-6	295	27	180	100	23	115	50
VWI 16-6	340	32	200	110	27	140	65

Custom made, also with flattening available.

Number close to code constitutes chain, used in combination with product.

Material: 1.4404 (AISI 316 L) from VWI 4-6

Material: 1.4462 (AISI F51 / AISI 318 LN) from VWI 5-6-6 to VWI 16-6)

pewag VAWI Special master link assembly for wire ropes

One for all.

With its flattened transition links, this stainless steel master link assembly for wire ropes opens up universal connection possibilities. If safety is your primary concern, you can't go wrong with this IV-leg master link assembly with extra-large transition links to create III- and IV-leg wire rope slings. The assembly is wide enough to fit two rope thimbles per transition link and is electrically welded and stamped for an extra-clean finish.

The manufacturing process of this corrosion-resistant, grade 6 master link assembly is similar to DIN 5688-1 and DIN 3088-1989. It is 100 % proof tested. The stamp and CE-mark ensure that the product is clearly identifiable.

Preferred areas of application for the VAWI IV-leg master link assembly G6 are water and wastewater applications and the product can also be used in connection with chemicals and food products; however, restrictions will apply and we recommend that you contact the manufacturer for advice prior to exposing the product to such use.

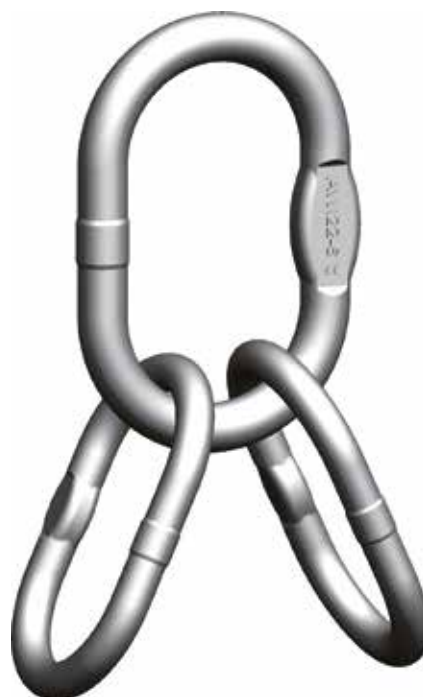

VAWI Special master link assembly for wire ropes

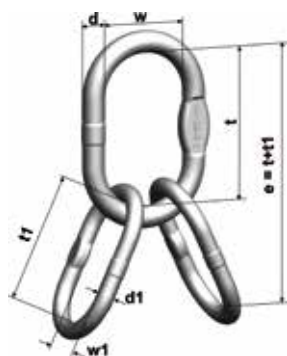

Code	Consisting of	Fits on single hook acc. DIN 15401 no.	Fits on double hook acc. DIN 15402 no.	Load capacity 0°-45° [kg]	Weight [kg/pc.]
VAWI 6-6	AWI 16-6 + 2 AWI 13-6	2.50	4	1,850	1.21
VAWI 7/8-6	AWI 18-6 + 2 AWI 16-6	5	6	3,350	1.98
VAWI 10-6	AWI 22-6 + 2 AWI 22-6	6	8	5,250	4.80
VAWI 13-6	AWI 26-6 + 2 AWI 26-6	8	10	8,900	7.38
VAWI 16-6	AWI 32-6 + 2 AWI 32-6	10	12	13,200	12.42

Code	e [mm]	d [mm]	t [mm]	w [mm]	d1 [mm]	t1 [mm]	w1 [mm]
VAWI 6-6	220	16	110	60	13	110	60
VAWI 7/8-6	245	18	135	75	16	110	60
VAWI 10-6	320	23	160	90	23	160	90
VAWI 13-6	360	27	180	100	27	180	100
VAWI 16-6	400	32	200	110	32	200	110

Number close to code constitutes chain, used in combination with product and attribution of ropes under construction of WLL in accordance of relevant rules of rope slings.

Material: 1.4462 (AISI F51 / AISI 318 LN)

pewag CWI Connex connecting link

For a seamless connection.

This stainless steel connecting link is drop-forged and stamped and consists of two symmetrical halves made from high-grade stainless steel. Its labour-intensive manufacturing process gives the product its outstanding quality. The connecting link may be divided and used for the universal assembly of chain slings, master links, master link assemblies, shortenings, shackles and other accessories and is guaranteed to be compatible with all pewag winner inox components of/for the same nominal size. The suspension bolt is locked by a stainless steel coil spring (mat. 1.4462) with a synthetic leeve. The bolt and the shell are available as spare parts.

The manufacturing process of the CWI Connex connecting link is similar to EN 1677-1. The product is suitable for straight pulling only; the simultaneous application of loads by two or more legs must be avoided. After the universally usable connecting link has been assembled and disassembled three times, it is recommended to use a new bolt and a new shell, to be mounted securely by a professional, to ensure that the quality of the product remains unimpaired. CBHWI spare part sets are available.

It is resistant to sea water and ideally suited for use in water and wastewater applications and can also be used in connection with chemicals and food products; however, restrictions will apply. The stamp and the CE-mark ensure that the product is clearly identifiable.

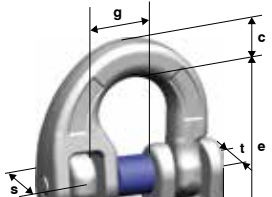

CWI Connex connecting link	Code	Load capacity [kg]	e [mm]	c [mm]	s [mm]	t [mm]	d [mm]	b [mm]	g [mm]	Weight [kg/pc.]
	CWI 5-6	630	36	7	10	11	7	34	13	0.06
	CWI 6-6	900	42	8	11	12	7	40	13	0.08
	CWI 7-6	1,250	54	9	13	14	9	51	17	0.14
	CWI 8-6	1,600	58	10	13	14	8.50	51	17	0.16
	CWI 10-6	2,500	73	13	18	18	13	70	25	0.37
	CWI 13-6	4,250	92	17	23	25	17	86	29	0.76
	CWI 16-6	6,300	104	21	32	28	20	105	37	1.41

Number close to code constitutes chain, used in combination with product.

Material: 1.4462 (AISI F51 / AISI 318 LN)
Material for bolt, sleeve and spring see spare parts set

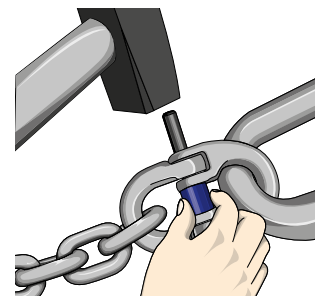
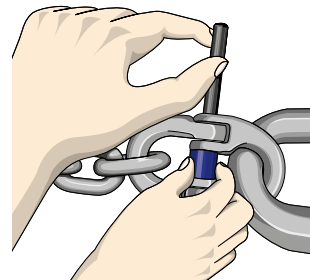
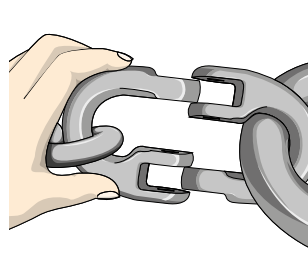
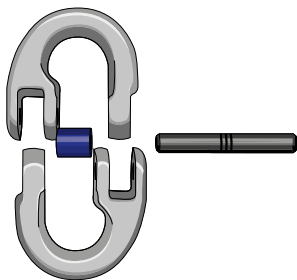

pewag HSWI Eye sling hook

The new face of resilience.

Like all pewag elements, this stainless steel eye sling hook is the result of a sophisticated manufacturing process. Using highgrade stainless steel, the hook is drop-forged and stamped. The compact design of the hook ensures the highest possible load capacity while maintaining a minimum product weight. The hook provides impact for protection for the safety latch, a large hook mouth and an extra-wide hook point to prevent accidental hooking into the chain. Due to the flat section on the eye, the hook is also compatible with alternative connecting systems.

This eye sling hook provides excellent directional stability and perfect guidance of the safety catch. It is particularly suited for the assembly of welded and assembled chain slings as well as wire rope slings. The safety catch engages with the hook point, which provides an effective protection against lateral movements. Forged inspection marks that facilitate the visual recognition of the discard criteria complete this outstanding product.

The manufacturing process is similar to EN 1677-2. The stamp and the CE-mark ensure that the product is clearly identifiable. The safety catch is available as spare part SFGWI. Preferred areas of application are (sea-)water and wastewater applications and the product can also be used in connection with chemicals and food products; however, restrictions will apply.



HSWI Eye sling hook



Code	Load capacity [kg]	e [mm]	h [mm]	a [mm]	d1 [mm]	d2 [mm]	g1 [mm]	b [mm]	Weight [kg/pc.]
HSWI 5/6-6	900	84	20	14	21	8	22	67	0.25
HSWI 7/8-6	1,600	112	29	20	27	13	32	98	0.70
HSWI 10-6	2,500	133	33	28	37	15	39	115	1.35
HSWI 13-6	4,250	172	43	35	48	18	51	147	2.60
HSWI 16-6	6,300	213	51	44	55	24	66	182	4.85

Number close to code constitutes chain, used in combination with product.

Material: 1.4462 (AISI F51 / AISI 318 LN)

Material for bolt, safety catch and spring see spare parts set

pewag PWI Grab hook

Short and quick.

This parallel hook serves as a shortening hook for shortening chain legs. Like all pewag elements, the stainless shortening hook is manufactured to particularly high standards. It is drop-forged and stamped from high-quality stainless steel. This shortening hook enables an optimal interaction between chain and hook due to the special design of the chain support. A reduction of the load capacity of the sling is not necessary in the shortened condition. Loading at the tip of the hook is not permitted. To prevent this, the hook provides an extra wide hook tip. Due to the flat point at the eye and extra large eye design, the hook is also suitable for use with alternative connection systems. The parallel hook is suitable for the Connex and welded system. It is mounted in the sling by means of an additional Connex link or BWI link. Modified according to EN 1677-1 and DIN 5692.

Preferred areas of application for the PWI grab hook are (sea-) water and wastewater applications and the product can also be used in connection with chemicals and food products; however, restrictions will apply.



PWI Grab hook



Code	WLL [kg]	e [mm]	b [mm]	d1 [mm]	d2 [mm]	g [mm]	Weight [kg/pc.]
PWI 5/6	900	65	44	24,5	9	7,2	0,20

Material: 1.4462 (AISI F51 / AISI 318 LN)

pewag VLWI Chain shortener

Safety is key.

This corrosion-resistant chain shortener is manufactured from high-grade stainless steel and has a BWI transition link for the simple, effortless link-by-link shortening of stainless steel chains. In addition to being extremely convenient in its application, the shortener also offers the benefit of easy retrofitting in assembled systems and ensures that the chain cannot fall out even when it is shortened, as its proper weight will always lock it in place. The stamp and CE-mark ensure that the product is clearly identifiable.

Preferred areas of application for the VLWI shortener are water and wastewater applications and the product can also be used in connection with chemicals and food products; however, restrictions will apply and we recommend that you contact the manufacturer for advice prior to exposing the product to such use.



VLWI Chain shortener

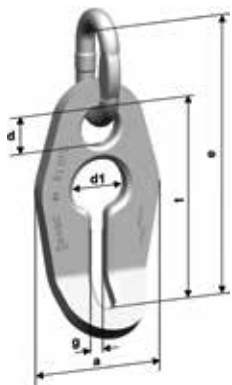

Code	Load capacity [kg]	e [mm]	e1 [mm]	a [mm]	d [mm]	d1 [mm]	g [mm]	Weight [kg/pc.]
VLWI 5/6-6	900	80	114	52	16	26	8	0.22
VLWI 7/8-6	1,600	111	156	68	22	34	11	0.57
VLWI 10-6	2,500	133	186	86	27	40	12	1.06
VLWI 13-6	4,250	169	242	108	32	52	16	2.22
VLWI 16-6	6,300	204	284	134	38	64	20	4.16

Number close to code constitutes chain, used in combination with product.

Material: 1.4404 (AISI 316 L) for link and 1.4571 (AISI 316 Ti) for shortener from VLWI 5/6-6

Material: 1.4462 (AISI F51 / AISI 318 LN) for link and 1.4571 (AISI 316 Ti) for shortener from VLWI 7/8-6 to VLWI 16-6



Correct application



Correct application



Correct application



Wrong application

pewag[®] LCWI Loop connector

Stay in the loop.

Special applications such as the lifting of pumps require user-friendly solutions that simplify work processes and comply with all legal regulations. For pewag, these aspects are a matter of course – and the LCWI loop connector is a prime example of a product that encompasses all of them.

With the loop connector, forming loops even through narrow eyes (they must of course be large enough to feed the chain through) is easy, quick and does not require an additional connecting link. The loops will not tighten and, thanks to the special design, it is no longer necessary to reduce the load capacity down to 80 % when using a loop.

The connector is stamped with the manufacturer's symbol, CE marking and batch number and comes with a full operating manual.



LCWI Loop connector

Code	Load capacity [kg]	e [mm]	d [mm]	a [mm]	b [mm]	c [mm]	Weight [kg/pc.]
LCWI 5-6 C	630	31	6	10	6	12	0.068

Maximum temperature in use is 110° C.

Material: 1.4462 (AISI F51 / AISI 318 LN)

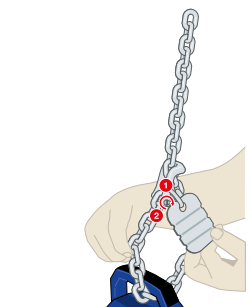
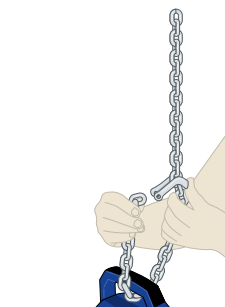
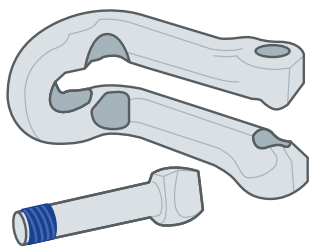

pewag SSWI Safety shackle

Withstands any vibrations.

Yet another quality product made from high-grade steel that is forged, stamped and tested to within an inch of its life before it is put to use. This stainless steel safety shackle with a reinforced suspension bolt is designed for use as an end fitting in chain and wire rope slings and in connection with pump chains for the lifting of submersible pumps and breathers, where maximum safety is key. The product comes with a safety mechanism to protect against unintentional release. Please note that it cannot be mounted directly onto the chain and onto some transition links.

If used correctly, the SSWI Safety shackle easily withstands vibrations. Each of these safety products bears the CE-mark and has a code on the bolt and pins for added traceability.

Preferred areas of application for the shackle are water and wastewater applications and the product can also be used in connection with chemicals and food products; however, restrictions will apply and we recommend that you contact the manufacturer for advice prior to exposing the product to such use.



SSWI Safety shackle	Code	Load capacity [kg]	e [mm]	a [mm]	b [mm]	d [mm]	d1 [mm]	c [mm]	Weight [kg/pc.]
	SSWI 0,9 t-S	900	41	10	21.50	10	11	22	0.14
	SSWI 0,63 t-S	630	33	8	18	8	9	18	0.07
	SSWI 0,63 t-S-W	630	35	8	21.50	8	9	18	0.08
	SSWI 1,6 t-S	1,600	41	12	26	12	13	25	0.22
	SSWI 2,5 t-S	2,500	62	15	36	15	17	32	0.52
	SSWI 4,25 t-S	4,250	78	18	42	18	21	46	1.00
	SSWI 6,3 t-S	6,300	109	24	58	24	29	59	2.40
	SSWI 26-C ¹⁾	13,000	152	34	76	34	38	75	5.80

¹⁾ Maximum temperature in use is 110° C.

Other sizes and special models available on request!
Stronger shackles are also available on request.
Currently SSWI without UKCA marking, on request possible with UKCA marking.

Bolt safety mechanism:

S = with safety splint

C = with bolt adhesive, at the moment only size SSWI 26 is available, further sizes upon request.

Material: 1.4404 (AISI 316 L) from SSWI 0,63t-S to SSWI 6,3t-S

Material: 1.4542 (AISI 630) from SSWI 26-C

pewag PLGWI gamma inox



pewag winner profilift lifting point PLGWI gamma inox. Rust-resistant ease of use.

Naturally, the PLGW lifting point is also available in a rust-resistant version – as the PLGWI eye bolt, offering all the tried-and-tested pewag advantages: Versatility when it comes to areas of application, accurately fitted measurements, optimised working load limits and unsurpassed ease-of-use. Please note that a hexagon Allen wrench is required as a tool for mounting and removal.

And the PLGWI offers even more than that:

The eyebolt is 360° rotatable, comes with an interchangeable special screw that is 100% crack-tested and is marked with the working load limit and the thread size!

An integrated sleeve protects the surface of the load. The batch number displayed on all load-bearing parts such as the eye and screws as well as the serial number make identification, traceability and performance of mandatory, regular inspections easier than ever.

Additional benefits of the PLGW inox lifting point:

- Extendable areas of application thanks to Duplex steel with heightened rust-resistance
- The PRE/N value that determines the alloy composition and thus also the level of corrosion-resistance, lies at approx. 34.

Optionally also available with peTAG (NFC chip) or PIP (colour marking).



PLGWI gamma inox M12, M16 - available as a "basic" version (tool for assembly required)



PLGWI gamma inox M20 –available in „basic" version (tool for assembly required) and „supreme" version (no tool required for assembly)

Permitted usage

For working load limits in the permitted directions of pull, please refer to the working load limit table.

- Adjust the lifting point in the permitted load direction before loading.
- Loadable with a 4-fold safety under break in all directions.

Non-permitted usage

During assembly, ensure that improper loading does not arise due to any of the following factors:

- Direction of pull is obstructed
- Direction of pull is not within the indicated area
- Loading ring rests against edges or loads.

For additional details and information, please refer to the full operating manual.

Each lifting point comes with an individual serial number.

For detailed information such as lashing type, number of legs, angle of inclination etc., please refer to the tables on the following two pages.

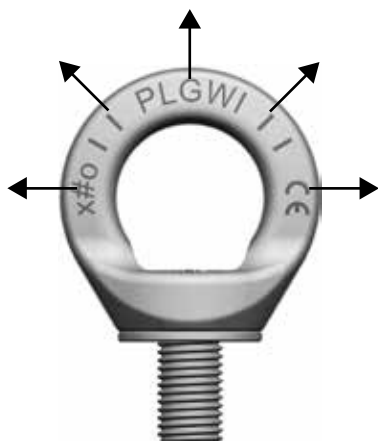

Permissible load directions

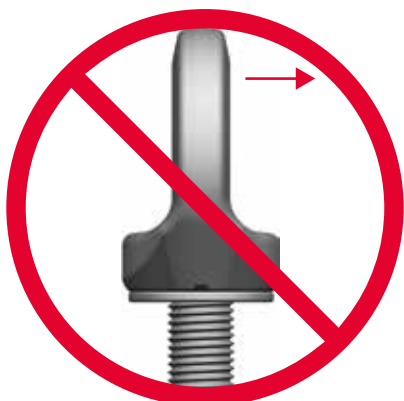

Non-permissible load directions

pewag PLGWI gamma inox

Lashing type
Number of legs
Angle of inclination

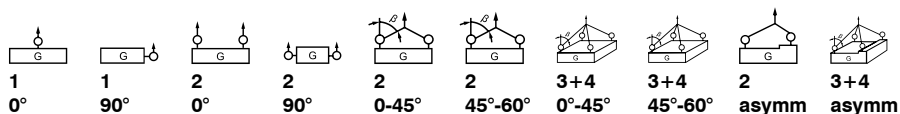

Code	Thread [mm]	Torque [Nm]	Working load limit [kg]									
			1.500	500	3.000	1.000	700	500	1.060	750	500	500
PLGWI 0,5 t	M12	25	1.500	500	3.000	1.000	700	500	1.060	750	500	500
PLGWI 1 t	M16	50	3.000	1.000	6.000	2.000	1.400	1.000	2.100	1.500	1.000	1.000
PLGWI 2 t	M20	115	3.800	2.000	7.600	4.000	2.800	2.000	4.200	3.000	2.000	2.000

Code	Thread [mm]	Working load limit [kg]	a [mm]	b [mm]	c [mm]	d [mm]	e [mm]	f [mm]	n [mm]	n max [mm]	Ø [mm]	Weight [kg/unit]
PLGWI 1 t	M16	1.000	35	64	14	35	67	35	24	160	10	0,36
PLGWI 2 t	M20	2.000	40	72	17	40	80	45	30	160	12	0,60

Safety factor 4:1

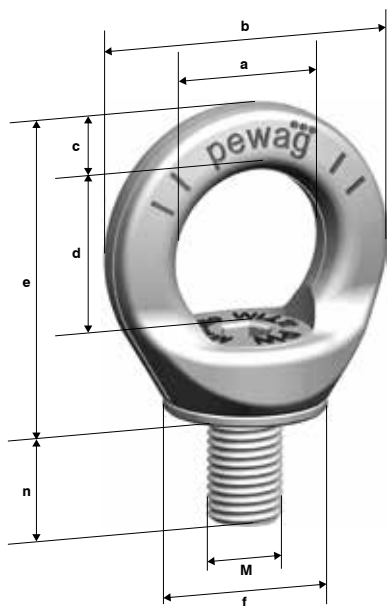

Marking on the screw + exploded view

Straight pull 0°	Lateral load direction „permitted“ (ring is aligned) 90°	Lateral load direction not permitted (ring is not aligned)
Higher working load limits for loading along the screw axis (column "0°" in the working load limit table)	Higher working load limits for loading vertically to the screw axis (column "90°" in the working load limit table)	Application not permitted due to unstable conditions. The ring could turn suddenly while under load - high risk for load and/or persons!

pewag CBHWI Bolts + safety bush

Because safety comes first.

Any whole is more than the sum of its parts – and this is particularly true for the high-quality combinations within the pewag portfolio. The CBHWI safety set that goes with the Connex connector consists of a stainless steel suspension bolt and a spiral spring (Mat. 1.4462) that is set in an enlarged synthetic sleeve for particularly easy fitting, ensuring that the suspension bolt always locks perfectly in place.

Variety of use: CBHWI Bolts and safety bushes for grade 6 plus correspond to the design of CBHWI grade 5 and may therefore also be used as replacement parts. Please note the modified material properties of grade 6 plus!

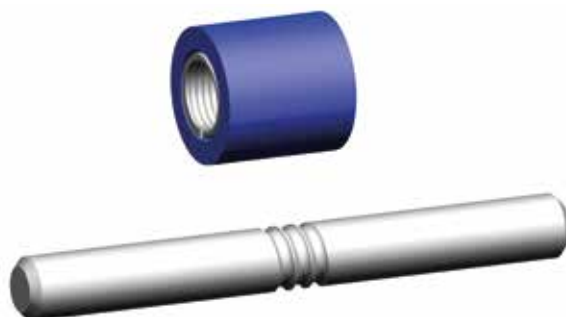

CBHWI Bolts + safety bush

Code

For connecting link

CBHWI 5-6	CWI 5-6
CBHWI 6-6	CWI 6-6
CBHWI 7/8-6	CWI 7-6 + CWI 8-6
CBHWI 10-6	CWI 10-6
CBHWI 13-6	CWI 13-6
CBHWI 16-6	CWI 16-6

Material: 1.4462 (AISI F51 / AISI 318 LN) for bolt and spring
Sleeve is made of plastic

pewag SFGWI Safety catch set

Extra strength you can count on.

It's all in the name: Safety is what this stainless steel safety catch set with an extra-strong spring and rivetable safety pin is all about. The catch is simple to use and its quality speaks for itself, with even the tiniest parts manufactured to absolute perfection.



SFGWI Safety catch set	Code	For hook
	SFGWI 5	HSWI 5 stamped HSK 5 or HK 5
	SFGWI 7	HSWI 7 stamped HSK 7 or HK 7
	SFGWI 10	HSWI 10 stamped HSK 10 or HK 10
	SFGWI 13	HSWI 13 stamped HSK 13 or HK 13
	SFGWI 16	HSWI 16 stamped HSK 16 or HK 16
	SFGWI 5/6-6	HSWI 5/6-6 stamped HSWI 5/6-6
	SFGWI 7/8-6	HSWI 7/8-6 stamped HSWI 7/8-6
	SFGWI 10-6	HSWI 10-6 stamped HSWI 10-6
	SFGWI 13-6	HSWI 13-6 stamped HSWI 13-6
	SFGWI 16-6	HSWI 16-6 stamped HSWI 16-6

Material: 1.4581 (AISI 316 Nb) for safety catch G6
 Material: 1.4462 (AISI F51 / AISI 318 LN) for spring G6
 Material: 1.4404 (AISI 316 L) for rivet bolt G5 and G6
 Material: 1.4301 (AISI 304) for safety catch G5
 Material: 1.4310 (AISI 301) for spring G5

pewag IDWOX Identification tag

New look.

pewag always remains focused on continuously improving its products wherever possible. For this reason, our lifting identification tags now come in a rectangular shape with notches at the sides, which offers several benefits, all leading towards greater safety. The tags are made from corrosion-resistant material and are attached to the sling with a corrosion-resistant link, thus significantly improving safety for the user.

The idea was to eliminate the errors that were made repeatedly in the past, when users took the number of corners of the identification tag and the chain dimensions to work out the maximum load capacity without taking the markings on the identification tag into consideration. This is due to the fact that in all standard documentation for lifting chains, the number of corners featured by the identification tag corresponds to the grade category of the lifting chain. However, standards only ever describe the minimum requirements of a product and may of course be exceeded.

A rectangular identification tag effectively prevents these sort of errors from occurring and offers users the following benefits:

- Prevents misjudging the carrying capacity of the lifting chain as the user is forced to look at the tag prior to each lifting process.
- When the marking is not observed, the lifting chain will be classed as a maximum grade 4.
- Corrosion-resistant; therefore resistant to acids, caustics and their vapours.
- It is assembled to the chain sling with a mounting device which makes the identification tag undetachable.
- All information is engraved, allowing for customer-specific markings.
- Pre-stamped year dates for periodic inspections make the date of the last inspection immediately apparent.
- For periodic inspections, only the month needs to be stamped.
- 2 in 1: TKWI avoids using another tag for test intervals.

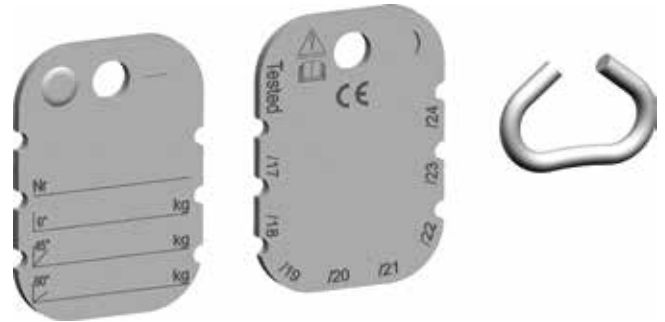

Fully customisable.

Quality should never have to remain anonymous. This stainless steel ID tag set, consisting of a TKWI identification tag and a mounting device, is now fully customisable to engrave the customer name or any other logo. Inspection data may also be entered and a plaque for different grade classifications makes things easier for technicians!

IDWOX Identification tag	Code	For lifting chains	Consisting of
	IDWOX G6 for chain 4 + 5 Identification tag set neutral	I- and multi-leg slings	tag + master link open 5 x 28 + safety information
	IDWOX G6 for chain 6 + 26 Identification tag set neutral	I- and multi-leg slings	tag + master link open 8 x 62 + safety information
Material: 1.4571 (AISI 316 Ti) for tag 1.4404 (AISI 316 L) for link			

pewag winner inox pump chains in G6 plus

Product overview

Content

pewag PCWI Stainless steel pump chains	42-44
Wox-S Chain inox	45
S-PCWI service pump chain slings	46





pewag PCWI Stainless steel pump chains

All-round power packs.

The high-grade pump chains have a load capacity that ranges from 320 to max. 12,000 kg. Their welded design, solid construction and range of components makes them particularly suitable for submersible pumps and breathers in water and wastewater applications.

Systematic expediency

These pump chains are tested for perfection and serialised with a dedicated identification tag and test certificate, issued individually for each chain. Enlarged master links at the beginning, at segmented intervals and at the end of the chain make them ideally suited for step-by-step lowering, lifting or locking.

Upon request, we also offer customised variations:

- Two-legged system with “Y” for pumps equipped with 2 eye screws.
- Alternative end fittings, such as eye hooks, BWI links or shackles.
- Additional stabilisation chain.
- Variation of standard segment length.
- Customised models available.
- Stainless steel hoist chains for pump stations are available upon request.

We recommend safety shackles type SSWI for joining the pump to the chain. When placing an order, please indicate the desired total length of the chain or the number of segments as well as the end fitting (e.g. AWI Master link). **Note:** The actual length is a multiple of the segment length, plus the length of the end fitting!

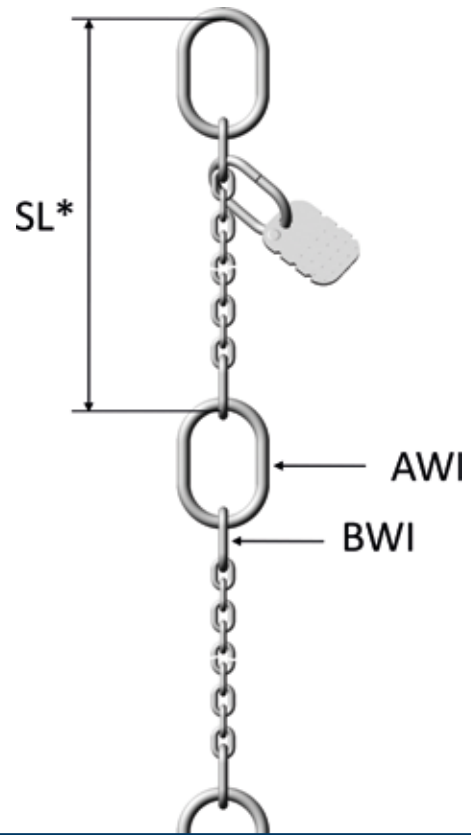

Code	WLL [kg]	Master link	Dimensions AWI [mm]	Transition link	Dimensions BWI [mm]	Chain type	Number of links	Segment length* [mm]	Weight SL* [kg]	Appropriately shackle / typ**
PCWI 4-6/320	320	AWI 6	6x60x35	-	-	WOX 4x12-5	77	984	0.39	SSWI 0.63 t -S/-W
PCWI 4-6/400	400	AWI 8	8x60x35	BWI 5	5x26x13	WOX 4x12	73	988	0.39	SSWI 0.63 t -S/-W
PCWI 5-6/560	560	AWI 8	8x60x35	BWI 7	7x36x16	WOX 5x15	53	943	0.43	SSWI 0.63 t -S/-W
PCWI 5-6/630	630	AWI 10	10x80x50	BWI 7	7x36x16	WOX 5x15	53	963	0.62	SSWI 0.63 t -S/-W
PCWI 6-6	850	AWI 10	10x80x50	BWI 7	7x36x16	WOX 6x18	47	998	0.68	SSWI 0.9 t -S
PCWI 7-6	1,250	AWI 13	13x110x60	BWI 9	9x44x20	WOX 7x21	37	975	1.35	SSWI 1.6 t -S
PCWI 8-6	1,600	AWI 13	13x110x60	BWI 10	10x44x20	WOX 8x24	33	990	1.70	SSWI 1.6 t -S
PCWI 10-6	2,500	AWI 16	16x110x60	BWI 13	13x54x25	WOX 10x30	25	968	2.60	SSWI 2.5 t -S
PCWI 13-6	3,500	AWI 18	18x135x75	BWI 16	16x70x34	WOX 13x39	19	1,016	4.50	SSWI 4.25 -S
PCWI 16-6	6,300	AWI 22	23x160x90	BWI 20	20x85x40	WOX 16x48	15	1,050	8.00	SSWI 6.3 t -S
PCWI 20-5	8,000	AWI 26	27x180x100	BWI 22	23x115x50	WOX 20x60	27	2,030	21.00	SSWI 26-C
PCWI 26-4+	12,000	AWI 45	45x340x180	BWI 32	32x150x70	WOX 26x78	19	2,122	43.20	SSWI 26-C

Now available with Duplex material

Code	WLL [kg]	Master link	Dimensions AWI [mm]	Transition link	Dimensions BWI [mm]	Chain type	Number of links	Segment length* [mm]	Weight SL* [kg]	Appropriately shackle / typ**
PCWI 8-6 D ¹⁾	1,600	AWI 13	13x110x60	BWI 10	10x44x20	WOX 8x24 D	33	990	1.70	SSWI 1.6 t -S
PCWI 10-6 D ¹⁾	2,500	AWI 16	16x110x60	BWI 13	13x54x25	WOX 10x30 D	25	968	2.60	SSWI 2.5 t -S

¹⁾ PCWI pump sling in Duplex material 1.4462 (AISI F51 / AISI 318 LN), except SSWI

All dimensions given in this folder are nominal dimensions. Depending on the manufacturing process they are subject to various manufacturing tolerances.

*SL consisting of 1 x AWI, 2 x BWI, WOX chain in standard length. PCWI 4/320 is manufactured without transition link BWI.

**Please pay attention to the matching shackle. If necessary, please contact our customer service.

pewag PCWI Stainless steel pump chains

Variants and possibilities to assembly PCWI.



PCWI Standard



PCWI with 2-legs in the end



pewag PCWI Stainless steel pump chains

Variants and certain options of PCWI.

Thanks to the usage of the LCWI at the end of the pump chain system neither a special link or a master link (AWI) is required. Furthermore, there is no blend of a segment if it is cutted from bonds. This needs to be done by an expert. Attaching this system, the chain is leaded over the wider handle of pumps in order to create a loop. Thus, there is no need for oversized and expensive shackles anymore.

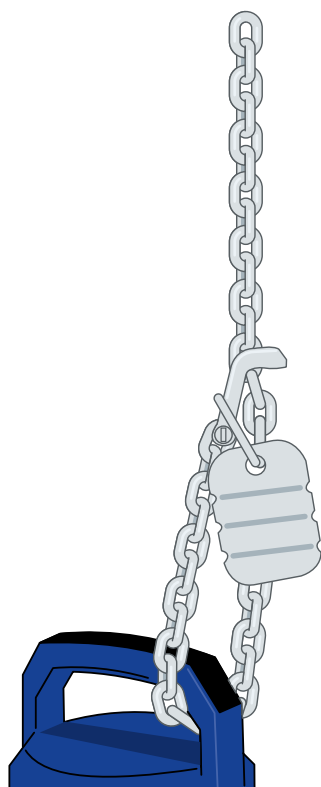

PCWI with Loop Connector



Assembly:

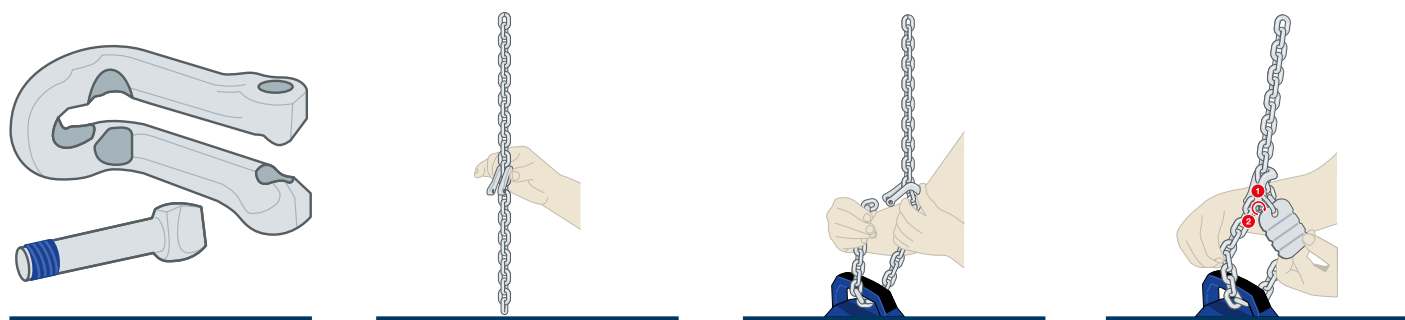

pewag WOX-S Chain inox

Simply smart.

The already impressively versatile pewag WOX chain has now been developed further for use in specific pump chain applications, opening up an even wider range of possible use. The WOX-S chain is the brilliant result of these development efforts and makes an ideal addition to the pewag range of pump chains.

When assembled as a service pump chain, it may only be used in conjunction with specific lifting appliances. The chain has a higher resistance to acids and caustic solutions and is easy to identify thanks to the distinctive WOX-S marking. The WOX-S is now ready for use as part of your pump chain system!



WOX-S Chain inox

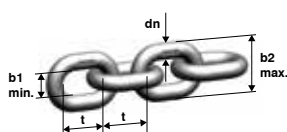

Code	Standard delivery length [m] ^{*)}	Nominal diameter dn [mm]	Pitch t [mm]	Inside width b1 min. [mm]	Outside width b2 max. [mm]	Load capacity hand-operated hoist [kg]	Load capacity motorised hoist [kg]	Breaking force [kN]	Weight [kg/m]
WOX-S 5-6	50	5	15	6	16.90	640	500	25.10	0.57
WOX-S 6,3x19,5-5 ¹⁾	50	6.3	19.50	7.40	20.70	800	-	31.20	0.86
WOX-S 7,9x23-6 ¹⁾	50	7.9	23	9.60	26.20	1200	-	58.90	1.37

Material: 1.4404 (AISI 316 L)

¹⁾ Available on request

^{*)} Other special lengths available on request.

All dimensions given in this operating manual are nominal dimensions. Depending on the manufacturing process they are subject to various manufacturing tolerances.

pewag S-PCWI service pump chain slings

SPCWI with LCWI

When used with the LCWI, neither a special link nor a master link (AWI) is needed at the end of the pump chain system. When cropping is required, segments can no longer be miscut (please note that this process may be performed by professionals only).

In this system, the chain is guided over the usually wider pump handle and a loop is formed using the LCWI, eliminating the need for an oversized and expensive shackle.

SPCWI with special link + shackle

With this pump chain system, a transition link is welded on at the end of the WOX-S chain leg. In this way, the chain leg may be connected to the pump using an SSWI shackle. The WLL tag is attached to the lower end and is undetachable. For professional application WOX-S chain must be used.

Note: Maximum load capacity with special link: 500 kg.

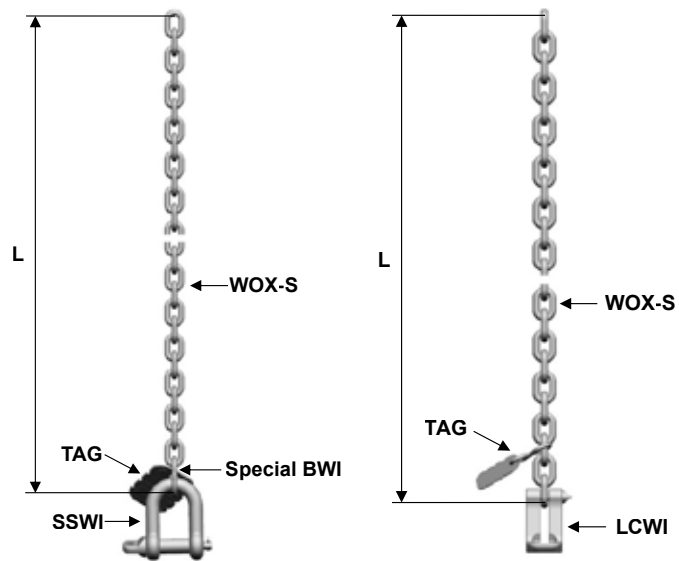

Code	Load capacity hand-operated hoist [kg]	Load capacity [kg]	Chain type	End component End link	Total length L *) [m]	Weight of sling [kg/m]	Appropriately shackle / typ
S-PCWI 5x15-6	630	630	WOX-S 5x15	LCWI 5-6 C	3, 4, 5, 6, 7, 8, 8,5, 9, 10, 11	0.58	-
S-PCWI 5x15-5	500	500	WOX-S 5x15	Special BWI 5,8	3, 4, 5, 6, 7, 8, 9, 10	0.56	SSWI 0,63 t-S/-W
S-PCWI 6,3x19,5-5 ¹⁾	500	500	WOX-S 6,3x19,5	Special BWI 5,8	5, 6, 7, 8, 9, 10	0.86	SSWI 0,63 t-S/-W
S-PCWI 7,9x23-6 ¹⁾	1200	1200	WOX-S 7,9x23	BWI 9-6	5, 6, 7, 8, 9, 10	1.37	SSWI 1,6 t-S

¹⁾ Available on request

*) Other special lengths available on request.

All dimensions given in this operating manual are nominal dimensions. Depending on the manufacturing process they are subject to various manufacturing tolerances.

Application of LCWI:

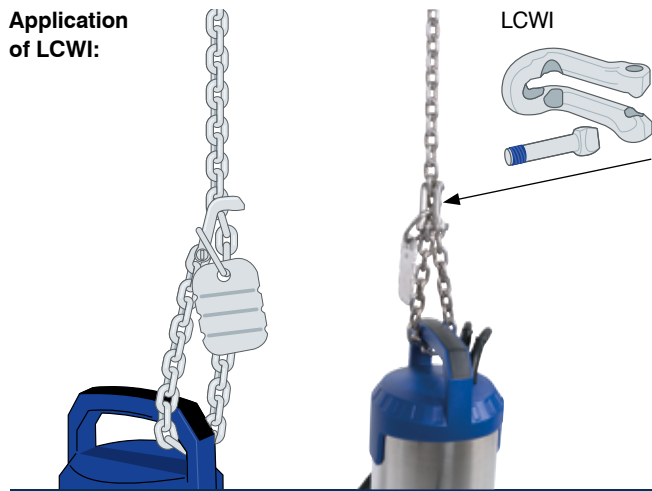

SPCWI with LCWI



SPCWI with special link and shackle

User information

For stainless steel chain systems

User information

General information	48-49
Chain slings: Use and safety	50-51
Resistance tables	52-53



User information

General and safety information on the use, storage, inspection and maintenance of pewag winner inox chain slings.

General information.

The pewag winner inox range was designed for a wide range of applications and easily handles different designs, loads and sling types – this is exactly what we had in mind during the development process. All information on construction and rating of load capacity in the catalogues that follow the uniform load method of rating take this versatility into account. An alternative method for rating the capacity of chain slings also exists, where the exclusive, specific case of application as well as all operating conditions must be known. In such a case, we recommend that you contact the pewag technical service team, as the information given in the catalogues does not apply to such processes.

Responsible use is key

If used correctly and by qualified personnel, pewag winner inox chain slings have a long service life and provide the highest possible degree of safety. Personal and material injury and damage can be prevented by reading and understanding the user information and acting responsibly and providently when using lifting equipment.

Modifications of the condition as delivered.

We strongly recommend using exclusively the supplied original components of the pewag winner inox chain slings, for instance bolts, safety pins, screws etc. Modifying the original condition of the chain slings by bending, grinding, separation of parts, welding, drilling, stamping etc. means exposing yourself and others to unnecessary risks as safety can no longer be guaranteed and use thus becomes hazardous. Hazardous conditions and modifications also include exposure to temperatures of more than 350 °C and the removal of safety components such as safety pins, latches etc. If surface treatments should be required, please contact pewag for advice prior to performing such treatment. Dipping, flashing, blasting or removing the coating with chemicals are all dangerous processes that may give rise to hazards. Always contact our technical service department for advice.

Restrictions of use.

For adverse operating conditions and / or hazardous conditions, please see the table on page 16.

Temperature

The table on page 16 lists the reduction of load capacities as a result of high temperature. These apply until the chain and / or lifting components have returned to room temperature. pewag winner inox lifting accessories must not be used outside the stated temperature range. In the event of temperatures outside this range, the chain slings must be removed from service. For applications within higher temperature we are happy to advise you.

Effects of acids, caustic solutions and chemicals

If exposure to chemicals such as acids, caustic solutions and chemicals and their vapours, food, cosmetic or pharmaceutical products is unavoidable, pewag experts must be consulted for prior approval. The tables on page 55 also deal with this important issue.

Hazardous conditions

The load capacities indicated in this catalogue are based on the assumption that no hazardous conditions apply. Such hazardous conditions include offshore applications, the lifting of people and potentially dangerous loads such as liquid metals, corrosive or caustic substances or nuclear material. In such special cases, the extent of the hazard must be assessed by an expert beforehand and the load capacity adjusted accordingly. Improper use in hazardous conditions must be avoided. In general, care should be taken to avoid hazardous conditions.

Prevention is the best cure: Essential inspections and tests

Before a lifting component can be used, the following checks must be performed:

- Is the lifting chain really the one that was ordered?
- Has the test certificate and / or certificate of conformity been supplied?
- Do the markings and load capacities indicated on the chain correspond to those indicated on the test certificate / certificate of conformity?
- Where applicable: Have all details of the chain sling been entered into the chain records?
- Has every employee read and understood the user information for chain slings?

The chain slings must be checked for visible damage or signs of wear prior to each use. In case of doubt of visible damage, the chain slings must no longer be used and handed to a qualified person for inspection.

The chain sling must be inspected by a qualified person in accordance with national regulations, but at least once every 12 months. Please note that this interval must be shortened if the lifting chain is frequently working at maximum load capacity! In case of extraordinary events such as uncontrolled exposure to high temperatures, the chain sling must also be subjected to an additional inspection. We recommend subjecting the chain sling to a load test with 1.5 times the working load limit every two years, followed by a visual inspection, or another type of crack test.

Visual inspection criteria

The use of all parts must be discontinued if one or several of the criteria listed below apply:

- Broken part.
- Missing or illegible marking on the chain sling, i.e. identification data and / or load capacity indication.
- Deformation of suspension or sling parts or the chain itself.
- Elongation of the chain. The chain must be discarded if: $t > 1,05 t_n$
- Signs of wear, as determined as the mean value of two measurements of diameters d_1 and d_2 carried out at a right angle (see picture). The chain must be discarded if:

$$d_m = \frac{d_1 + d_2}{2} < 0,9 d_n$$

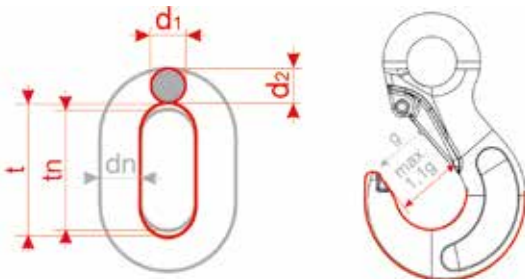

- Visible damage such as cuts, notches, grooves, surface cracks, discolouration due to heat, signs of subsequent welding, bent or twisted links or other flaws.
- Obvious signs of wear or chemical abrasion (such as pitting), or when a permissible wear tolerance has been reached as per the table below.
- Cracks and cross-cracks that are visible to the naked eye.
- Missing or non-functional safety device as well as signs of widening or twisting of hooks, i.e. noticeable enlargement of the opening or other forms of deformation. The enlargement of the opening must not exceed 10 % of the nominal value! Please note that an opened-out safety catch is a sign that the hook is overloaded.

Maximum approved dimensional change:

Designation	Dimensions	Admissible deviation
Chain	d_m	- 10 %
	t	+ 5 %
Links	d	- 10 %
	t	+ 10 %
Hooks	e	+ 5 %
	d_2 and h	- 10 %
	g	+ 10 %
CWI	Halves loose	No changing admissible
	e	+ 5 %
	c	- 10 %
Shackles	Bolt loose	No changing admissible
Loop Connector	e	+ 5 %
	d, d_1 and M	- 10 %
Connex bolts	d	- 10 %

Maintenance and repair

pewag winner inox lifting accessories and chain slings should only be repaired by qualified personnel to minimise the risk of improper handling.

Correct documentation

All tests and inspections and their results must be recorded and kept on file throughout the service life of the chain sling. Careful use is the basis of any maintenance and repair activities of our stainless steel solutions.

Proper storage

pewag winner inox chain slings must always be stored clean and dry. Chemical, thermal or mechanical influences during storage should be avoided.

Correct use of chain slings.

Correct angle of inclination

To ensure safe use, slinging points and chain types must be selected in such a way that the angles of inclination of all legs lie within the data given on the identification tag. Ideally, all angles of inclination should be the same. Always avoid angles of inclination of less than 15° because of the high risk of load instability. Never use chain slings with an angle of inclination exceeding 60°!

Edge load – what you need to know

The maximum load capacity of pewag winner inox chain slings is based on the assumption that the individual chain legs are pulled straight under load, i.e. that they do not run over edges. In the case of edge loading, load protection (packing) should be used to avoid damage. See the picture below for proper and improper use:

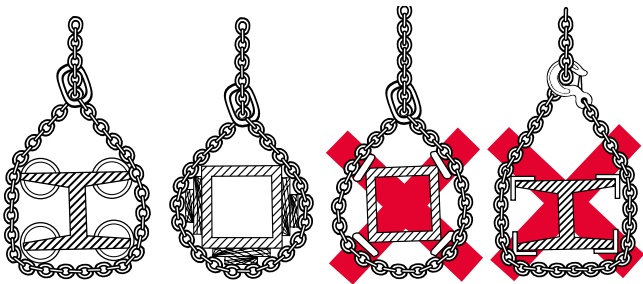

If chains are guided over edges without proper protection, their load capacity is reduced significantly and safe use is compromised. For the corresponding load factors, please refer to the table on page 18. In situations where chains have to be looped around a beam or other round-shaped loads, the diameter should be minimum 3 times the chain pitch. For smaller diameters, the load capacity of the chains must be reduced by 50 %.

Avoid shock loads to ensure safe loading

For the maximum load capacity of pewag winner inox lifting chains to apply, it is assumed that the individual chain strands are not exposed to shock loads. Where shock loads cannot be avoided, the load factors specified on page 18 apply to determine the final load capacity.

Classification of impacts

- Slight impact occurs for instance when accelerating the lifting or lowering movement.
- Medium impact occurs for instance when the chain slips while adjusting itself to the shape of the load.
- Strong impact occurs for instance when the load falls into the unloaded chain.

Vibrations

If used correctly, pewag winner inox lifting chains and components are able to withstand high load levels and are designed for 20,000 load cycles. However, there is a risk of damage in cases of high dynamic stress. For such cases, the occupational insurance association Metall Nord Süd recommends reducing the stress at working load limit by using higher dimensioned chains and components (thickness and length).

Symmetrical loading

The maximum load capacities for pewag winner inox chain slings are based on the assumption that the load placed on the individual chain legs is distributed symmetrically. Lifting of the load then results in inclination at equal angles, with the individual legs being symmetrical to each other.

The load is considered symmetrical if all of the following conditions are met:

- The load is smaller than 80 % of the stated maximum load capacity.
- The angles of inclination of all chain legs are no smaller than 15° and resemble each other or do not differ from each other by more than 15°.
- In the case of three and four-leg sling chains, the corresponding plane angles must be within 15° of each other.

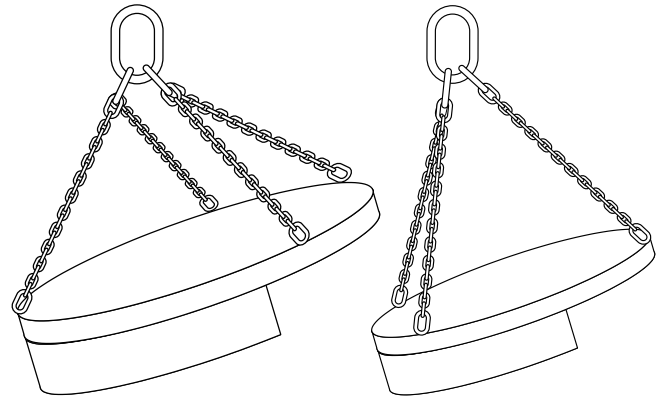

The majority of the load is carried by II strand (leg)

The majority of the load is carried by II strand (leg)

Always be careful!

If not all of the parameters listed above apply, the load is considered asymmetrical and the lifting process must be assessed by an expert. If in doubt, only one chain leg may be considered load-bearing. Please check the load capacity table for applicable load capacity limits.

Use for intended purpose: Why it matters

pewag chain slings offer perfect quality if they are used for the intended purpose. In cases where not all individual legs are used at the same time, please refer to the load capacity table to determine the correct load capacity limit. In case of doubt or as an alternative, change the load capacity as indicated in the table below:

Precautionary measures

- Hang any individual chain legs that are not being used back into the master link to prevent hazards caused by freely swinging chains or unintended hooking.
- Before using several chain slings at the same time, make sure that the crane hook is big enough for all the master rings. Make sure that the master rings cannot fall out of the hook during lifting.
- Angles of inclination of more than 45° are not permitted!
- If several chain slings are used at the same time, please ensure that they have the same nominal thickness and grade.

Type of chain sling	Number of individual strands (legs) used	Use factor in relation to the working load limit given on the tag
Two-stranded (II-leg)	1	1/2
Three- and four-stranded (II/IV-leg)	2	2/3
Three- and four-stranded (II/IV-leg)	1	1/3
2x single stranded (single leg)	2	1.4 up to 0°-45°
2x two-stranded (II leg)	3 or 4	1.5 up to 0°-45° and 45°-60°

Detailed original operating manuals for individual products are available for download at www.pewag.com. Our manuals are subject to an ongoing improvement process and therefore only valid in their latest version.

Resistance has a name: pewag!

Resistance values for different media.

The following values are guideline values to indicate resistance to different material, liquids and chemicals that may deviate in practice.

The corrosion values are based on the assumption that corrosion sets in equally across the entire surface. One measurement of corrosion results from the weight difference of the material after a certain period of time, with the material being weighed before and after corrosion. The weight difference is expressed in grams per square metre and hour. This number corresponds roughly to denudation in millimetres per year. Exact and binding values can only be provided following tests for precisely defined corrosive agents and without dirt or impurities.

Professionals at work

pewag products are used in the food sector, for instance in dairies, slaughterhouses etc., in the chemical industry, for instance in dyeing plants, and in many other areas where safe lifting, conveying and securing is essential.

Material no.	DIN-shortname	Cr %	Ni %	Mo %	Ti
1.4571 (AISI 316 Ti)	X6 CrNiMoTi 17-12-2	16.5-18.5	10.5-13.5	2.0-2.5	Addition
1.4404 (AISI 316 L)	X2 CrNiMo 17-12-2	16.0-18.0	10.0-13.0	2.0-2.5	-
1.4462 (AISI F51 / AISI 318 LN)	X2 CrNiMoN 22-5-3	21.0-23.0	4.5-6.5	2.5-3.5	-
1.4581 (AISI 316 Nb)	GX5 CrNiMoNb 19-11-2	18.0-20.0	9.0-12.0	2.0-2.5	-

Corroding media	Concentration %	Temperature °C	Resistance 1.4571/1.4404	Resistance 1.4462
Atmosph. corrosion*			0	0
Benzine		20/boiling	0	0
Formic-acid HCOOH	10-50	20	0	0
	80	boiling	1	1
		20	0	0
		boiling	3	1
Ammonia NH ₄ OH	all	20/boiling	0	0
Ammoniumnitrat NH ₄ NO ₃	hydrous, cold saturated solvent	20/boiling	0	0
Chlorine water saturated		20	1	-
Acetic-acid CH ₃ COOH	10	20	0	0
	10-50	boiling	0	0-1
	80	boiling	1 P	1
Fatty-acid (oil)		150	0	0
Hydrofluoric acid	10	20	2 P	2 P
	40	20	3	3
Tannic-acid	50	20/boiling	0	0
Potassium hydroxide KOH	hot saturated	120	1 S	1 S
Lime milk Ca(OH) ₂ (Calciumhydroxid)		20/boiling	0	0
Seawater		20	0 P	0 P
		boiling	1	0
Phosphor-acid H ₃ PO ₄	1	20	0	0
	50	boiling	1	1
	80	boiling	2	1
	concentrated	boiling	3	3
Nitric-acid HNO ₃	1-90	20	0	0
	50	boiling	1	1
Hydrochloric-acid HCl	0.2-0.5	20	0 P	0 P
		50	1 P	0.2 %: 0 P // 0.5 %: 1 P
	1	20	0 P	0 P
		50	1 P	1 P
	2	20-50	1 P	1 P
Sulfuric-acid H ₂ SO ₄	0.1	boiling	0	0+
	1	20	0	0
		80	1	0
		boiling	1	1
	5	20	0	0
		50	1	0
		boiling	2	1
	10	20	0	0
		50	1	0
		80	2	1
		boiling	2	2
Trichlorethylene CHCl:CCl ₂		20/boiling	0 P	0 P

* The complete resistance depends on kind, composition and the water-content of the atmosphere and is in industrial areas and near the coast considerably less than in the highlands or in dry regions.

0 = completely resistant
 1 = practically resistant
 2 = little resistant
 3 = theoretically non-resistant
 P = pitting
 S = stress corrosion

	g/m ² h
0 corresp. to a weight-loss up to	0.1
1 corresp. to a weight-loss from	0.1-1.0
2 corresp. to a weight-loss from	1.0-10.0
3 corresp. to a weight-loss over	10.0
Completely non-resistant	-

pewag lifting solutions

From over half a millennium of company history, the drive for quality and the pursuit of excellence has become our pewag standard. The development and production of all our products is motivated by these characteristics to meet all our customers' expectations. This quality standard and our extensive service are the foundation of our success.



Developed and manufactured in Europe



Patented



Online training via pewag academy



Comes with an individual serial number



Optionally available with peTAG NFC Chip

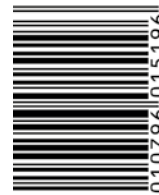

KA/22/00560 9 010796015196



www.pewag.com

pewag austria GmbH

A-8041 Graz, Gaslaternenweg 4, Phone: +43 (0) 50 50 11-0, Fax: +43 (0) 50 50 11-100,
saleinfo@pewag.com, www.pewag.com

