

pewag winner profilift lifting points

For safe lifting and lashing



Developed & manufactured at the heart of Europe – for use throughout the world.

Experience since 1479



Content

Screw-in and weldable lifting points from pewag.

pewag winner profilift lifting points set new standards for the lifting and moving of loads.

Our innovative product range offers highest standards when it comes to quality, safety and user-friendliness. All products are compatible with the popular pewag winner lifting chain programme.

pewag group

Introduction of the pewag group	4-5
History and quality management	6
Business areas and the environment	7
Locations	8-9

peTAG solution

peTAG solution	10-11
----------------	-------

pewag lifting points at a glance

pewag lifting points at a glance	12-13
Comparison between pewag lifting points / Icons	14-19

Screw-in lifting points

pewag - innovation that is safe as houses	20
Screw-in lifting points	21-50
Calculation of the thread length	51

Weldable hooks and lifting points

Weldable hooks and lifting points	52-59
-----------------------------------	-------

Anchorage points - fall protection

Anchorage points – fall protection	60-65
The individual pewag solution for your challenge	66-67

Spare parts

Spare parts	68-75
-------------	-------

User information

User information	76-79
------------------	-------



Full Member

Welcome to the pewag group

We are an internationally operating group of companies. Our track record goes back to the year 1479.

Mission Statement

pewag group's Mission Statement expresses the goals of our actions as follows:

With our joy for innovation, we strive to make all products of the pewag group the best in the respective markets. The high quality of our products and services as well as our employees' passionate dedication are the foundation to our pursuit of outstanding services and complete customer satisfaction.

Principles of pewag group

Leading in Quality

The values of our product brands are demonstrated by our first-class quality and innovations and are communicated consistently and coherently.

We anticipate market demands and changes in the environment and adapt our strategies, organizations and actions accordingly to satisfy our customers' needs through providing an optimal price-performance ratio: timely delivery, efficient and obliging service.

Leading in Responsibility

We commit ourselves to careful treatment of the environment, by reducing the use of energy and raw materials, ensuring the longevity of our products and making them recyclable.

We value an open, honest and team-oriented work-style, which is based on transparent communication honoring ideas, opinions and experience of our employees as valuable inputs for our decision making process.

We strive for stable and fair partnerships with our employees, customers, suppliers and other business partners and take social aspects into consideration when making business decisions.

Leading in Technology

We secure our technological strength by striving for product quality, constant improvements and innovations of products, as well as manufacturing processes.

We strive to be the best in product technology. This ensures that our customers always have optimal solutions available and that we expand and protect our market position.

Leading in Economics

In all our processes we use due diligent business practices and efficiency and strive to improve these continuously.

In the long-term, we will continuously increase our economic performance to raise corporate value, achieve sustained growth and thus secure a successful future of the organization.

We are a modern group of companies which looks back to a tradition and experience of more than 500 years. Since our founding years, a lot has changed, but the values that made our success possible from the beginning remain.

**pewag group –
Innovation. Quality. Partnership.**

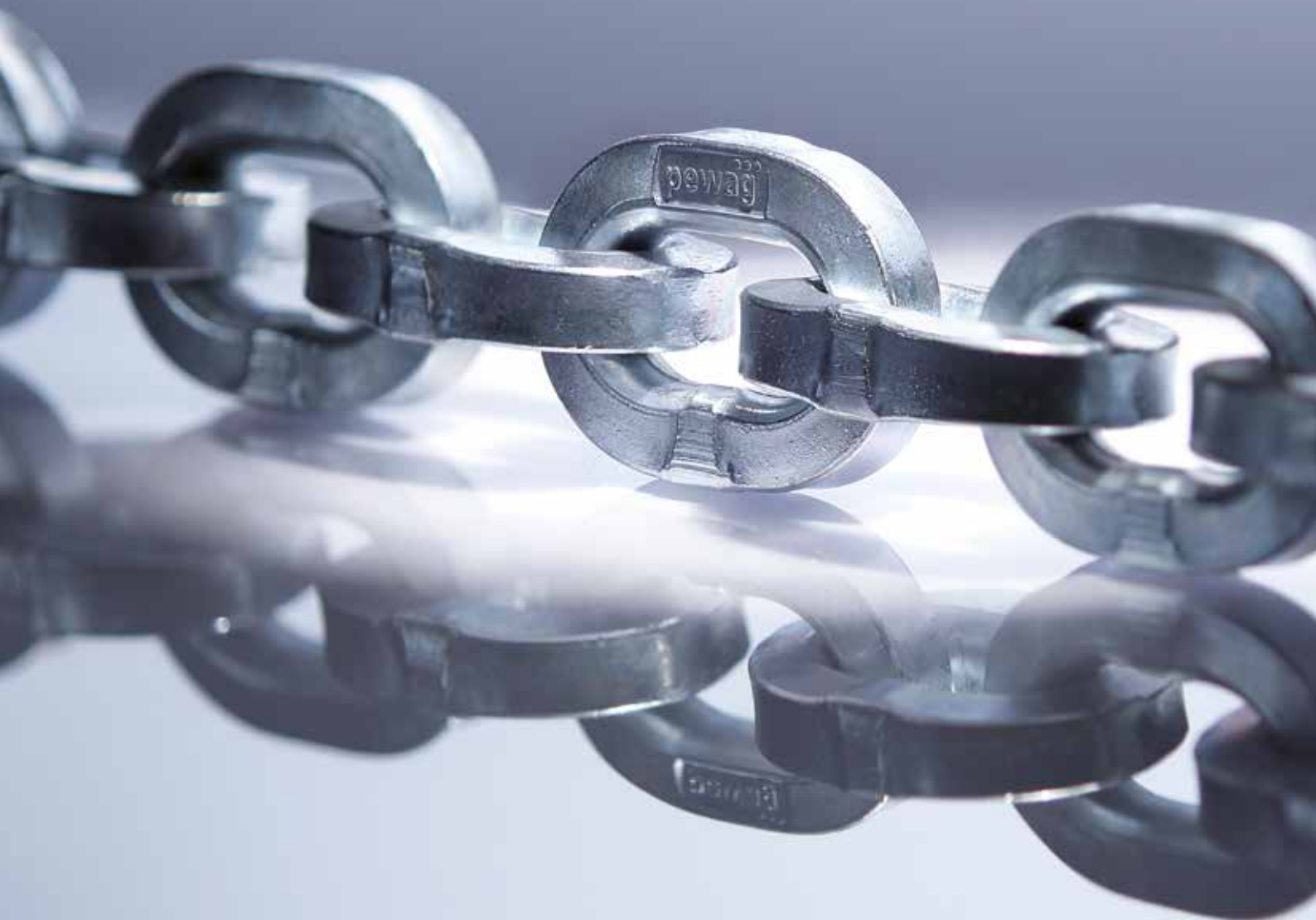

History of the pewag group

Quality management

Advantage through tradition

The history of pewag group goes back to the 15th century and therefore makes us one of the oldest chain manufacturer worldwide. With our experience we are ready for the future.

Timetable of important events

- 1479** First documented references of a forging plant in Brückl
- 1787** Foundation of a chain forge in Kapfenberg
- 1803** Foundation of a chain forge in Graz
- 1836** Establishment of an iron casting plant in Brückl
- 1912** Production of the first pewag snow chain
- 1923** Merger of plants in Graz and Kapfenberg – Creation of the name “pewag”
- 1972** Foundation of a sales company in Germany
- 1975** Foundation of a sales company in the USA
- 1993** Foundation of pewag austria GmbH
- 1994** Foundation of the first subsidiary in Czech Republic
- 1999** Acquisition of the Weissenfels Group
- 2003** Separation from the Weissenfels Group
- 2005** Reorganization into 2 groups:
Schneeketten Beteiligungs AG Group – Snow Chains
pewag austria GmbH Group – Technical Chains
- 2009** Acquisition of Chaineries Limousines S.A.S.
- 2012** Foundation of the first manufacturing company in the USA
- 2013/** Foundation of various international sales
- 2014** companies



Lithography forging plant Brückl 1855



Anchor chain forge 1878



Chain forgers 1956

Our main goal is customer satisfaction

In this instance, quality means that only those products and services are developed, manufactured and delivered which completely and without compromise satisfy the customer.

The pewag group’s quality policy, is underlined by the following basic principle: **“we supply high-end products and services to our customers that conform to the technical standards and requirements”**, can be summarised in the subsequent four points.

Market-oriented Quality

In order to maintain and to widen the competitive position of the pewag group, the quality of finished goods and services must be consistent with the specifications of the customer and also with their expectations of one of the leading companies. No product should ever pose a danger to people or the environment.

Economic Quality

As a profit-oriented company, quality is achieved by taking into consideration the material, personnel and financial resources; this means that we establish an appropriate best price/performance ratio for the customer within the acknowledged framework.

Quality Responsibility

Stringent demands are placed on all employees to ensure high standards of quality. No matter what hierarchical level, all managers are in charge of managing quality. Every employee within the pewag group should be educated, motivated and instructed by the management team. It is important for promoting high quality awareness that the education and training of employees is at the forefront, as each employee is responsible for the quality of his/her own work.

For each of our employees, the statement **“QUALITY STARTS WITH ME”** must be true!

Process-oriented Quality

The close interaction between sales, product development, production and customer service is regulated within the individual companies by fixed processes and activities, as well as responsibilities with the aim to reach and maintain the defined quality standards.



Business areas

Environment – we take responsibility

Working with pewag products

The pewag group has a substantial and diverse spectrum of products and services.

Our range of products varies from traction chains for tires (snow chains for passenger cars, trucks and special-purpose vehicles, tire protection chains for mining vehicles) over different industrial chains to products for the do-it-yourself sector (light chains, belts, etc.)



Segment A
Snow and forestry chains



Segment B
Hoist and conveyor chains



Segment C
Do-it-yourself



Segment D
Engineering



Segment F
Lifting and lashing chains



Segment G
Tire protection chains

Ecological awareness in all areas



Our company's manufacturing location in Kapfenberg, Austria, has been used for iron and steel production for over 270 years. A second facility located in Brückl, Austria, was first documented in records dating back to 1479. Based on this long manufacturing tradition, we take serious responsibility for our products, employees and the environment at all our international locations. Hence, one of our major concerns is to improve energy efficiency and, in doing so, to minimise energy consumption over a long period of time with the development of new production technologies. An important goal is to increase energy efficiency and consequently lower energy demand. Consequently, we develop our products to achieve longer product life-cycles and lower weight but simultaneously, increasing their working load capacities and the safety for our customers. We are committed to upholding all relevant energy and environmental standards by setting clearly defined goals and continually improving our performance. To achieve this goal, we use modern manufacturing technologies. An important step is to provide the necessary resources and to include our employees in the process. We are convinced that well-informed and motivated employees can actively participate in environmental conservation.

Wherever we are unable to avoid an environmental impact, we have set ourselves the goal to continually reduce our energy consumption, waste and environmentally harmful emissions. When purchasing new equipment, we strive to find the best and most efficient technical solution possible. It is important for us to promote the purchase of energy efficient products and services.

Our process-oriented management system regulates the documentation concerning all environmental relevant procedures. It also encompasses preventative measures for possible failures, as well as behavioural instructions for regular and/or extraordinary operational procedures. By systematically monitoring and assessing our environmental activities, we are quickly able to resolve deviances and to take corrective action. This process extends throughout the whole organisation to optimise all business processes. We strive to engage in an open dialogue with our customers, neighbours and authorities to inform them of our energy and environmental engagements.

Through specific communication we want to inform our customers about the environmental aspects of our products – specifically inform them about the longevity of our products. Through meaningful communication, we strive to motivate our suppliers and customers to think – in turn – about their environmental footprint and to put into practice similar environmental standards in their businesses.

Customer proximity

International presence

In the ambitious five-hundred year history pewag has evolved from a small and modest company to a global organization with several subgroups.

With 16 production and over 50 sales and other locations on all five continents, the pewag group documented its claim as one of the world's leading chain manufacturers. Further, pewag group is active with 45 sales partners worldwide.

In addition to the numerous locations pewag as an international company relies on it's extensive, strong, and professional partner network. These collaborations provide optimal customer service in currently more than 100 countries around the world.

Production and sales locations

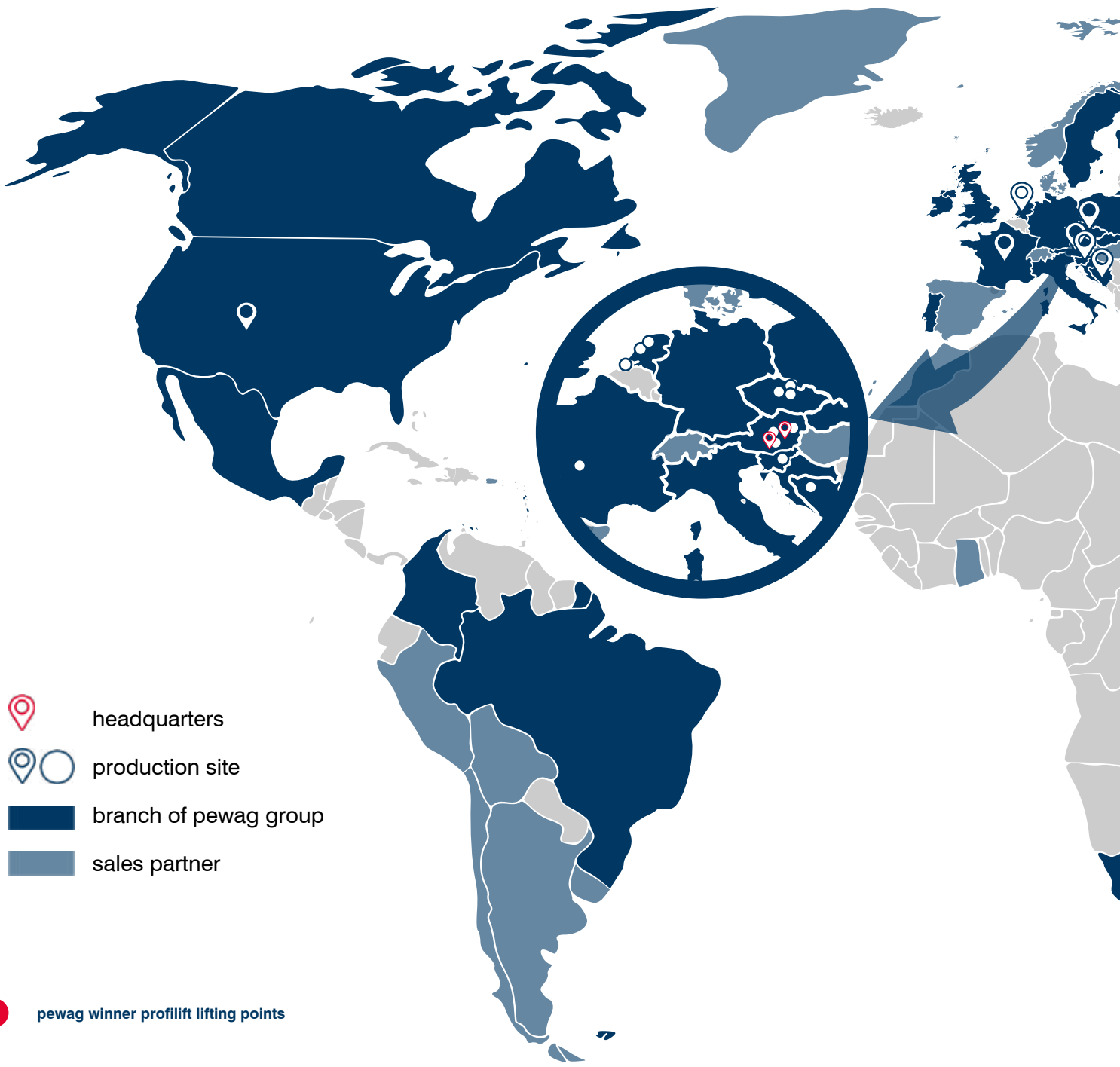

pewag group presents
itself on the internet. More ...

www.pewag-group.com

www.pewag.com

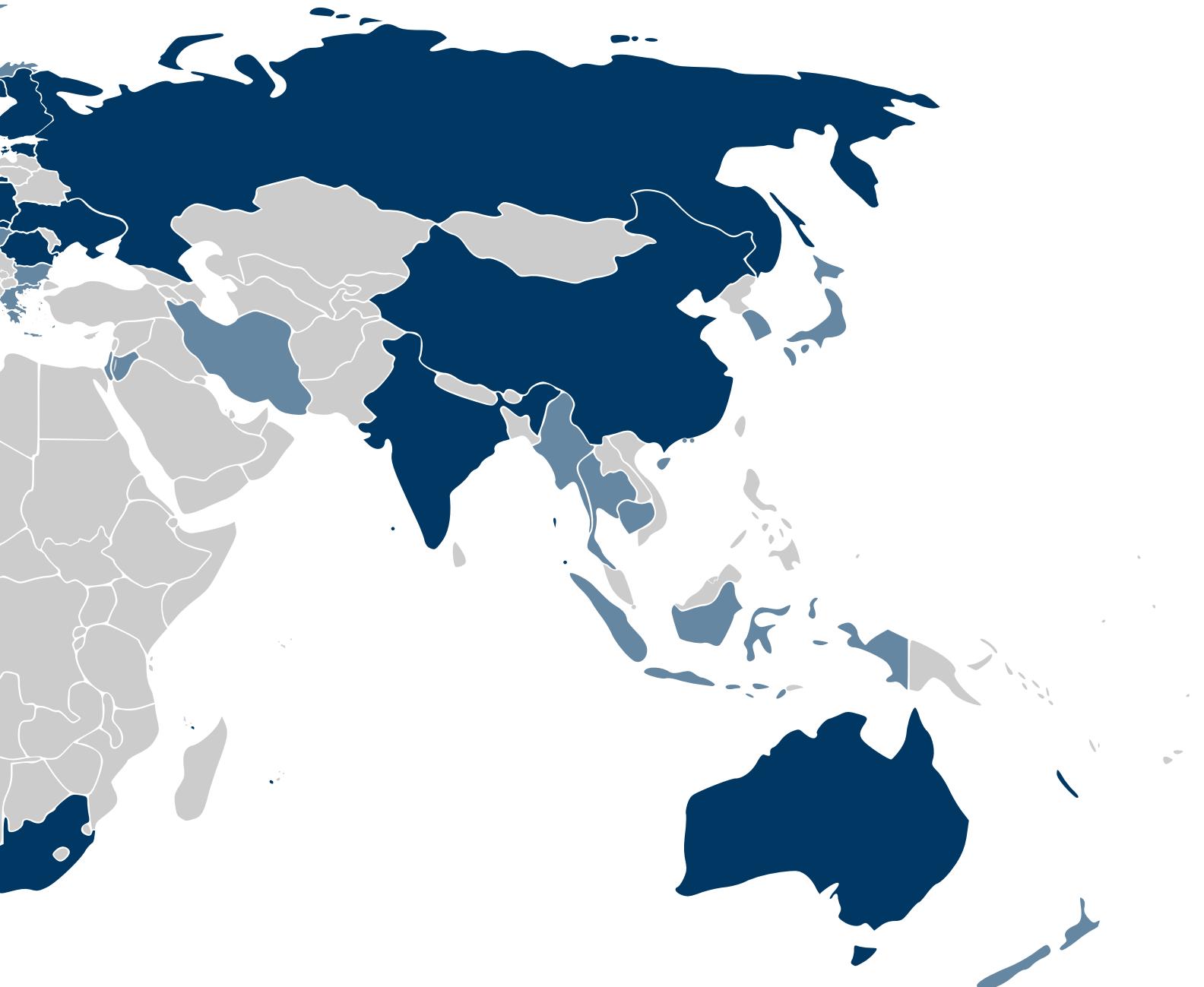

pewag Creating links

The peTAG solution enables the company-wide, flexible servicing and administration of a wide range of objects.

peTAG solution

The intelligent solution for clear object identification, seamless data transfer, straightforward servicing of objects, safe archiving of data, efficient interaction with partner companies and much more.

peTAG info

Smart, free-of-charge access to product-specific information via the mobile web.



peTAG manager

PC and mobile end devices work hand in hand with this adaptable, high-performance platform that stands out in any working environment and improves data quality at the same time. Additional, expensive reading devices and manual data transfer belong to the past.



The pewag profilift lifting points PLAW, PLBW, PLGW, PLDW, PLEW and PLZW come with a pilot hole for the transponder (Ø 4 mm).

peTAG solution



peTAG solution Key facts



Intelligent software

User-specific adaptation of object data, inspection processes and steps. Automated compilation, dispatch and archiving of inspection reports. Sophisticated authorisation concept.



Save time & money

Efficient documentation of working processes, thereby making daily workflows easier. Seamless data exchange, error-free data communication.



Mobile solution

Direct, location-independent data retrieval (e. g. working load limit, safety information, latest inspection report etc.). Smart servicing of objects via the mobile app. Offline availability.



Linked partnerships

Easy exchange and efficient interaction between service providers, dealers and customers. Improved service and data quality. Increased satisfaction and loyalty.



Always up to date

Access to the latest product data and information. Overview of all inspection data. Documented inspection. Full traceability of the object history.





Screw-in and weldable hooks and lifting points, anchorage points.

Variety has a name: pewag! The proflift product portfolio consists of high-quality products that are perfectly suitable for almost any lifting application

PLAW alpha	Code	Thread [mm]	Working load limit [kg]
	PLAW 0,3 t	M8	300
	PLAW 0,63 t	M10	630
	PLAW 1 t	M12	1.000
	PLAW 1,5 t	M16	1.500
	PLAW 2,5 t	M20	2.500
	PLAW 4 t (/13)	M24	4.000
	PLAW 6 t	M30	6.000
	PLAW 7 t	M36	7.000
	PLAW 8 t	M36	8.000
	PLAW 10 t	M42	10.000
	PLAW 15 t	M42	15.000
	PLAW 20 t	M48	20.000

PLBW beta	Code	Thread [mm]	Working load limit [kg]
	PLBW 0,3 t	M8	300
	PLBW 0,6 t	M10	600
	PLBW 1 t	M12	1.000
	PLBW 1,3 t	M14	1.300
	PLBW 1,6 t	M16	1.600
	PLBW 2 t	M18	2.000
	PLBW 2,5 t	M20	2.500
	PLBW 3 t	M22	3.000
	PLBW 4 t	M24	4.000
	PLBW 5 t	M27	5.000
	PLBW 6,3 t	M30	6.300
	PLBW 8 t	M33	8.000
	PLBW 10 t	M36	10.000
	PLBW 12,5 t	M42	12.500
	PLBW 15 t	M48	15.000

PLGW gamma	Code	Thread [mm]	Working load limit [kg]
	PLGW 0,3 t	M8	300
	PLGW 0,5 t	M10	500
	PLGW 0,7 t	M12	700
	PLGW 1,5 t	M16	1.500
	PLGW 2,3 t	M20	2.300
	PLGW 3,2 t	M24	3.200
	PLGW 4,9 t	M30	4.900
	PLGW 7 t	M36	7.000
	PLGW 9 t	M42	9.000
	PLGW 12 t	M48	12.000

PLGW-SN gamma	Code	Thread [mm]	Working load limit [kg]
	PLGW-SN 0,3 t	M8	300
	PLGW-SN 0,5 t	M10	500
	PLGW-SN 0,7 t	M12	700
	PLGW-SN 1,5 t	M16	1.500
	PLGW-SN 2,3 t	M20	2.300
	PLGW-SN 3,5 t	M24	3.500
	PLGW-SN 4,9 t	M30	4.900

PLDW delta	Code	Thread [mm]	Working load limit [kg]
	PLDW 0,3 t	M8	300
	PLDW 0,5 t	M10	500
	PLDW 0,7 t	M12	700
	PLDW 1 t *	M14	1.000
	PLDW 1,5 t	M16	1.500
	PLDW 2,5 t	M20	2.500
	PLDW 4 t	M24	4.000
	PLDW 5,3 t	M30	5.300
	PLDW 6,7 t	M30	6.700
	PLDW 8 t	M36	8.000
	PLDW 10 t	M42	10.000
	PLDW 12 t	M45	12.000
	PLDW 13 t	M48	13.000
	PLDW 13 t	M52	13.000
	PLDW 24 t	M56	24.000
	PLDW 25 t	M64	25.000
	PLDW 40 t	M72	40.000
	PLDW 45 t	M80	45.000
	PLDW 55 t	M90	55.000
	PLDW 55 t	M100	55.000

PLZW zeta	Code	Thread [mm]	Working load limit [kg]
	PLZW 0,4 t	M8	400
	PLZW 0,63 t	M10	630
	PLZW 0,95 t	M12	950
	PLZW 1,8 t	M16	1.800
	PLZW 2,5 t	M20	2.500
	PLZW 4 t	M24	4.000
	PLZW 6,3 t	M30	6.300
	PLZW 10 t	M36	10.000
	PLZW 13 t	M42	13.000
	PLZW 15 t	M48	15.000



pewag winner proflift –
lifting points 2.0

Weldable lifting points and hooks

AOR Lashing point	Code	Thread [mm]	Working load limit [kg]
	AOR 10	M16	3.150
	AOR 13	M20	5.300
	AOR 16	M30	8.000
	AOR 22	M36	15.000
	AOR 26 ¹⁾	M42	21.200
	AOR 28 ¹⁾	M45	25.000
	AOR 32 ¹⁾	M56	31.500
	AOR 34 ¹⁾	M56	36.000

¹⁾ Please note: Subject to technical changes!
Not a stock item

RGS Eyebolt	Code	Thread [mm]	Working load limit [kg]
	RGS 8	M8	400
	RGS 10	M10	700
	RGS 12	M12	1.000
	RGS 14	M14	1.200
	RGS 16	M16	1.500
	RGS 20	M20	2.500
	RGS 24	M24	4.000
	RGS 30	M30	6.000
	RGS 36	M36	8.000
	RGS 42	M42	10.000
	RGS 48	M48	18.000

Screw-in, stainless lifting points

PLGWI Gamma inox	Code	Thread [mm]	Working load limit [kg]
	PLGWI 0,5 t	M12	500
	PLGWI 1 t	M16	1.000
	PLGWI 2 t*	M20	2.000

* Differs from picture shown

AWHW Weld-on hook	Code	Working load limit [kg]
	AWHW 1,3	1.300-
	AWHW 3,8	3.800-
	AWHW 6,3	6.300-
	AWHW 10	10.000-

PLEW eta	Code	Working load limit [kg]
	PLEW 1,5 t	1.500
	PLEW 2,5 t	2.500
	PLEW 4 t	4.000
	PLEW 6,7 t	6.700
	PLEW 10 t	10.000
	PLEW 19 t ¹⁾	19.000

¹⁾ Spring serves only as an aid during the welding process. With this type, the spring does not hold the ring in every position.

PLE/N eta	Code	Working load limit [kg]
	PLE/N 6	1.120
	PLE/N 8	2.000
	PLE/N 10	3.150
	PLE/N 13	5.300
	PLE/N 16	8.000
	PLE/N 22	15.000

Anchorage points - fall protection

PLGW-PSA Fall protection	Code	Persons
	PLGW PSA M12	1
	PLGW PSA M16	2
	PLGW PSA M20	2

Stainless anchorage points - fall protection

PLGWI-PSA Fall protection	Code	Persons
	PLGWI PSA M12	1
	PLGWI PSA M16	2

pewag Comparison between pewag lifting points / Icons

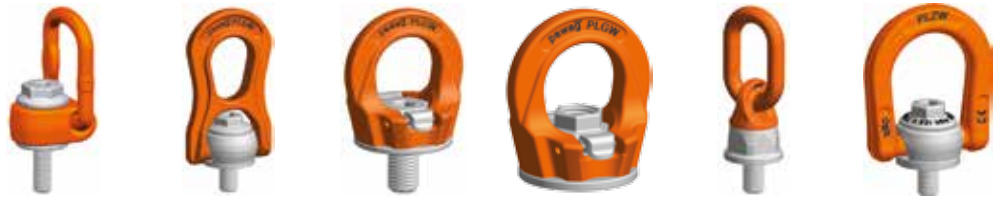

ICON		PLAW alpha	PLBW beta	PLGW gamma	PLGW-SN gamma	PLDW delta	PLZW zeta
	Optionally available with pewag peTAG NFC chip	<input checked="" type="checkbox"/>	<input checked="" type="checkbox"/>	<input checked="" type="checkbox"/>	<input checked="" type="checkbox"/>	<input checked="" type="checkbox"/>	<input checked="" type="checkbox"/>
	Spare parts are available	<input checked="" type="checkbox"/>	<input checked="" type="checkbox"/>	<input checked="" type="checkbox"/>	<input checked="" type="checkbox"/>	<input type="checkbox"/>	<input checked="" type="checkbox"/>
	Maximum and special length	<input checked="" type="checkbox"/>	<input checked="" type="checkbox"/>	<input checked="" type="checkbox"/>	<input type="checkbox"/>	<input checked="" type="checkbox"/>	<input checked="" type="checkbox"/>
	Available with a metric thread	<input checked="" type="checkbox"/>	<input checked="" type="checkbox"/>	<input checked="" type="checkbox"/>	<input checked="" type="checkbox"/>	<input checked="" type="checkbox"/>	<input checked="" type="checkbox"/>
	Available with an UNC thread	<input checked="" type="checkbox"/>	<input checked="" type="checkbox"/>	<input checked="" type="checkbox"/>	<input type="checkbox"/>	<input checked="" type="checkbox"/>	<input type="checkbox"/>
	Optional with PIP identification plug / colour marking	<input checked="" type="checkbox"/>	<input checked="" type="checkbox"/>	<input checked="" type="checkbox"/>	<input checked="" type="checkbox"/>	<input checked="" type="checkbox"/>	<input checked="" type="checkbox"/>
	Comes with an individual serial number	<input checked="" type="checkbox"/>	<input checked="" type="checkbox"/>	<input checked="" type="checkbox"/>	<input checked="" type="checkbox"/>	<input checked="" type="checkbox"/>	<input checked="" type="checkbox"/>
	Anti-corrosion coating	<input checked="" type="checkbox"/>	<input checked="" type="checkbox"/>	<input checked="" type="checkbox"/>	<input checked="" type="checkbox"/>	<input checked="" type="checkbox"/>	<input checked="" type="checkbox"/>
	Developed and manufactured in Europe	<input checked="" type="checkbox"/>	<input checked="" type="checkbox"/>	<input checked="" type="checkbox"/>	<input checked="" type="checkbox"/>	<input checked="" type="checkbox"/>	<input checked="" type="checkbox"/>
	May be used with a PLGIS Allen key	<input type="checkbox"/>	<input type="checkbox"/>	<input checked="" type="checkbox"/>	<input type="checkbox"/>	<input type="checkbox"/>	<input type="checkbox"/>



AOR lashing point	RGS eyebolt	PLGWI Gamma inox	AHW weld-on hook	PLEW eta	PLE/N eta	PLGW-PSA fall protection	PLGWI-PSA fall protection
<input type="checkbox"/>	<input type="checkbox"/>	<input checked="" type="checkbox"/>	<input type="checkbox"/>	<input checked="" type="checkbox"/>	<input type="checkbox"/>	<input checked="" type="checkbox"/>	<input checked="" type="checkbox"/>
<input type="checkbox"/>	<input type="checkbox"/>	<input checked="" type="checkbox"/>	<input checked="" type="checkbox"/>	<input type="checkbox"/>	<input type="checkbox"/>	<input checked="" type="checkbox"/>	<input checked="" type="checkbox"/>
<input type="checkbox"/>	<input type="checkbox"/>	<input type="checkbox"/>	<input type="checkbox"/>	<input type="checkbox"/>	<input type="checkbox"/>	<input checked="" type="checkbox"/>	<input checked="" type="checkbox"/>
<input checked="" type="checkbox"/>	<input checked="" type="checkbox"/>	<input checked="" type="checkbox"/>	<input type="checkbox"/>	<input type="checkbox"/>	<input type="checkbox"/>	<input checked="" type="checkbox"/>	<input checked="" type="checkbox"/>
<input type="checkbox"/>	<input type="checkbox"/>	<input type="checkbox"/>	<input type="checkbox"/>	<input type="checkbox"/>	<input type="checkbox"/>	<input type="checkbox"/>	<input type="checkbox"/>
<input type="checkbox"/>	<input type="checkbox"/>	<input checked="" type="checkbox"/>	<input type="checkbox"/>	<input checked="" type="checkbox"/>	<input type="checkbox"/>	<input checked="" type="checkbox"/>	<input checked="" type="checkbox"/>
<input type="checkbox"/>	<input type="checkbox"/>	<input checked="" type="checkbox"/>	<input type="checkbox"/>	<input checked="" type="checkbox"/>	<input type="checkbox"/>	<input checked="" type="checkbox"/>	<input checked="" type="checkbox"/>
<input checked="" type="checkbox"/>	<input checked="" type="checkbox"/>	<input checked="" type="checkbox"/>	<input checked="" type="checkbox"/>	<input checked="" type="checkbox"/>	<input checked="" type="checkbox"/>	<input checked="" type="checkbox"/>	<input checked="" type="checkbox"/>
<input type="checkbox"/>	<input type="checkbox"/>	<input checked="" type="checkbox"/>	<input checked="" type="checkbox"/>	<input checked="" type="checkbox"/>	<input checked="" type="checkbox"/>	<input checked="" type="checkbox"/>	<input checked="" type="checkbox"/>
<input type="checkbox"/>	<input type="checkbox"/>	<input checked="" type="checkbox"/>	<input type="checkbox"/>	<input type="checkbox"/>	<input type="checkbox"/>	<input checked="" type="checkbox"/>	<input checked="" type="checkbox"/>

pewag Comparison between pewag lifting points / Icons

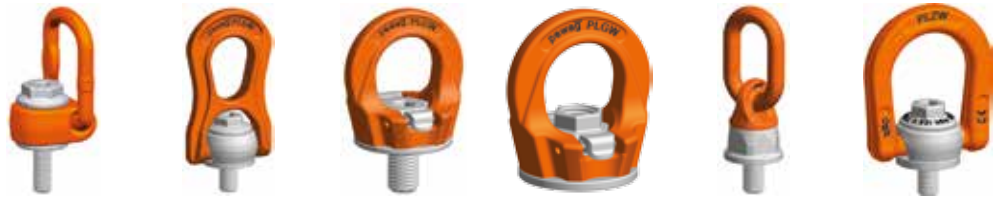



ICON		PLAW alpha	PLBW beta	PLGW gamma	PLGW-SN gamma	PLDW delta	PLZW zeta
	Crack-tested screw	<input checked="" type="checkbox"/>	<input checked="" type="checkbox"/>	<input checked="" type="checkbox"/>	<input checked="" type="checkbox"/>	<input checked="" type="checkbox"/>	<input checked="" type="checkbox"/>
	Safety factor 4:1	<input checked="" type="checkbox"/>	<input type="checkbox"/>	<input checked="" type="checkbox"/>	<input checked="" type="checkbox"/>	<input checked="" type="checkbox"/>	<input type="checkbox"/>
	Safety factor 5:1	<input type="checkbox"/>	<input checked="" type="checkbox"/>	<input type="checkbox"/>	<input type="checkbox"/>	<input type="checkbox"/>	<input checked="" type="checkbox"/>
	Torque marking	<input type="checkbox"/>	<input checked="" type="checkbox"/>	<input type="checkbox"/>	<input type="checkbox"/>	<input type="checkbox"/>	<input checked="" type="checkbox"/>
	Special colours available upon request	<input checked="" type="checkbox"/>	<input checked="" type="checkbox"/>	<input checked="" type="checkbox"/>	<input checked="" type="checkbox"/>	<input checked="" type="checkbox"/>	<input checked="" type="checkbox"/>
	3D CAD Drawings available	<input checked="" type="checkbox"/>	<input checked="" type="checkbox"/>	<input checked="" type="checkbox"/>	<input checked="" type="checkbox"/>	<input checked="" type="checkbox"/>	<input checked="" type="checkbox"/>
	Products made from stainless steel / rust-resistant	<input type="checkbox"/>	<input type="checkbox"/>	<input type="checkbox"/>	<input type="checkbox"/>	<input type="checkbox"/>	<input type="checkbox"/>
	Personal protection equipment	<input type="checkbox"/>	<input type="checkbox"/>	<input type="checkbox"/>	<input type="checkbox"/>	<input type="checkbox"/>	<input type="checkbox"/>
	Ring adjustable in any position (spring function)	<input checked="" type="checkbox"/>	<input checked="" type="checkbox"/>	<input type="checkbox"/>	<input type="checkbox"/>	<input type="checkbox"/>	<input checked="" type="checkbox"/> Optional
	Screw is exchangeable	<input checked="" type="checkbox"/>	<input checked="" type="checkbox"/>	<input checked="" type="checkbox"/>	<input type="checkbox"/>	<input type="checkbox"/>	<input checked="" type="checkbox"/>

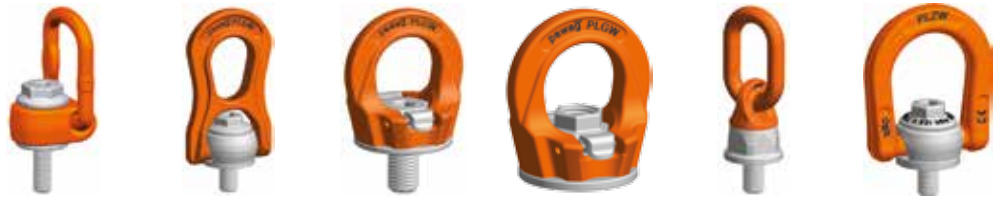

AOR lashing point	RGS eyebolt	PLGWI Gamma inox	AHW weld-on hook	PLEW eta	PLE/N eta	PLGW-PSA fall protection	PLGWI-PSA fall protection
<input type="checkbox"/>	<input type="checkbox"/>	<input checked="" type="checkbox"/>	<input type="checkbox"/>	<input type="checkbox"/>	<input type="checkbox"/>	<input checked="" type="checkbox"/>	<input checked="" type="checkbox"/>
<input checked="" type="checkbox"/>	<input checked="" type="checkbox"/>	<input checked="" type="checkbox"/>	<input checked="" type="checkbox"/>	<input checked="" type="checkbox"/>	<input checked="" type="checkbox"/>	<input type="checkbox"/>	<input type="checkbox"/>
<input type="checkbox"/>	<input type="checkbox"/>	<input type="checkbox"/>	<input type="checkbox"/>	<input type="checkbox"/>	<input type="checkbox"/>	<input type="checkbox"/>	<input type="checkbox"/>
<input type="checkbox"/>	<input type="checkbox"/>	<input type="checkbox"/>	<input type="checkbox"/>	<input type="checkbox"/>	<input type="checkbox"/>	<input type="checkbox"/>	<input type="checkbox"/>
<input type="checkbox"/>	<input type="checkbox"/>	<input checked="" type="checkbox"/>	<input type="checkbox"/>	<input checked="" type="checkbox"/>	<input checked="" type="checkbox"/>	<input type="checkbox"/>	<input type="checkbox"/>
<input type="checkbox"/>	<input type="checkbox"/>	<input checked="" type="checkbox"/>	<input checked="" type="checkbox"/>	<input checked="" type="checkbox"/>	<input checked="" type="checkbox"/>	<input checked="" type="checkbox"/>	<input checked="" type="checkbox"/>
<input type="checkbox"/>	<input type="checkbox"/>	<input checked="" type="checkbox"/>	<input type="checkbox"/>	<input type="checkbox"/>	<input type="checkbox"/>	<input type="checkbox"/>	<input checked="" type="checkbox"/>
<input type="checkbox"/>	<input type="checkbox"/>	<input type="checkbox"/>	<input type="checkbox"/>	<input type="checkbox"/>	<input type="checkbox"/>	<input checked="" type="checkbox"/>	<input checked="" type="checkbox"/>
<input type="checkbox"/>	<input type="checkbox"/>	<input type="checkbox"/>	<input type="checkbox"/>	<input checked="" type="checkbox"/>	<input checked="" type="checkbox"/>	<input type="checkbox"/>	<input type="checkbox"/>
<input type="checkbox"/>	<input type="checkbox"/>	<input checked="" type="checkbox"/>	<input type="checkbox"/>	<input type="checkbox"/>	<input type="checkbox"/>	<input checked="" type="checkbox"/>	<input checked="" type="checkbox"/>

pewag Comparison between pewag lifting points / Icons



ICON		PLAW alpha	PLBW beta	PLGW gamma	PLGW-SN gamma	PLDW delta	PLZW zeta
 PAT	Patented	<input checked="" type="checkbox"/>	<input checked="" type="checkbox"/>	<input checked="" type="checkbox"/>	<input checked="" type="checkbox"/>	<input type="checkbox"/>	<input checked="" type="checkbox"/>
 24h	Customised and maximal length manufactured within 24 h	<input checked="" type="checkbox"/>	<input checked="" type="checkbox"/>	<input checked="" type="checkbox"/>	<input type="checkbox"/>	<input checked="" type="checkbox"/>	<input checked="" type="checkbox"/>
 Graduation cap	Online training available via pewag academy	<input checked="" type="checkbox"/>	<input checked="" type="checkbox"/>	<input checked="" type="checkbox"/>	<input checked="" type="checkbox"/>	<input checked="" type="checkbox"/>	<input checked="" type="checkbox"/>
 Ring removal	Ring may be removed without tools	<input type="checkbox"/>	<input type="checkbox"/>	<input type="checkbox"/>	<input type="checkbox"/>	<input type="checkbox"/>	<input checked="" type="checkbox"/>
 360°	360° rotatable	<input checked="" type="checkbox"/>	<input checked="" type="checkbox"/>	<input checked="" type="checkbox"/>	<input checked="" type="checkbox"/>	<input checked="" type="checkbox"/>	<input checked="" type="checkbox"/>
 360° under load	Rotatable under load	<input type="checkbox"/>	<input type="checkbox"/>	<input type="checkbox"/>	<input type="checkbox"/>	<input checked="" type="checkbox"/>	<input type="checkbox"/>
 toolfree	Tool-free assembly possible	<input type="checkbox"/>	<input type="checkbox"/>	<input checked="" type="checkbox"/>	<input checked="" type="checkbox"/>	<input type="checkbox"/>	<input type="checkbox"/>



AOR lashing point	RGS eyebolt	PLGWI Gamma inox	AHW weld-on hook	PLEW eta	PLE/N eta	PLGW-PSA fall protection	PLGWI-PSA fall protection
<input type="checkbox"/>	<input type="checkbox"/>	<input type="checkbox"/>	<input type="checkbox"/>	<input checked="" type="checkbox"/>	<input type="checkbox"/>	<input checked="" type="checkbox"/>	<input type="checkbox"/>
<input type="checkbox"/>	<input type="checkbox"/>	<input checked="" type="checkbox"/>	<input type="checkbox"/>	<input type="checkbox"/>	<input type="checkbox"/>	<input checked="" type="checkbox"/>	<input checked="" type="checkbox"/>
<input type="checkbox"/>	<input checked="" type="checkbox"/>	<input type="checkbox"/>	<input type="checkbox"/>	<input checked="" type="checkbox"/>	<input checked="" type="checkbox"/>	<input checked="" type="checkbox"/>	<input checked="" type="checkbox"/>
<input type="checkbox"/>	<input type="checkbox"/>	<input type="checkbox"/>	<input type="checkbox"/>	<input type="checkbox"/>	<input type="checkbox"/>	<input type="checkbox"/>	<input type="checkbox"/>
<input type="checkbox"/>	<input type="checkbox"/>	<input checked="" type="checkbox"/>	<input type="checkbox"/>	<input type="checkbox"/>	<input type="checkbox"/>	<input checked="" type="checkbox"/>	<input checked="" type="checkbox"/>
<input type="checkbox"/>	<input type="checkbox"/>	<input type="checkbox"/>	<input type="checkbox"/>	<input type="checkbox"/>	<input type="checkbox"/>	<input type="checkbox"/>	<input type="checkbox"/>
<input type="checkbox"/>	<input checked="" type="checkbox"/>	<input type="checkbox"/>	<input type="checkbox"/>	<input type="checkbox"/>	<input type="checkbox"/>	<input type="checkbox"/>	<input type="checkbox"/>

pewag – innovation that is safe as houses

Lifting and lashing: the highest level of safety for operating staff and goods to be transported.

As a European premium chain manufacturer, pewag has always been synonymous with innovation, quality and safety, presenting innovations and defining new standards on a continuous basis.

The pewag winner profilift range of lifting points stands out for its excellent compatibility with the pewag winner lifting chains that are used extensively on a global scale. pewag winner profilift lifting points comply with Machine Directive 2006/42/EC and/or Machine Safety Regulation 2010, EN 1677-1 as well as with technical specifications. Sophisticated design makes this innovative range complete. The pewag winner profilift lifting points are produced in our ISO 9001 and 14001 certified plants and guarantee a 4- respectively 5-fold safety and a maximum dynamic load of min. 20.000 load cycles, tested at 1.5 times the working load limit.

Working load limits will vary according to the type of application, number of legs and angle of inclination and are listed in tables, which form an integral part of the detailed user manual that each lifting point comes with. Our website www.pewag.com also contains detailed information on working load limits, dimensions etc. as well as downloadable 3D models for design engineers.



Laser engraved marking of the serial number



Testing in the pewag lab



Original operating manual in compliance with Machine Directive EC

**pewag winner profilift –
our products master
any challenge.**



Screw-in lifting points

Product overview

Content

PLAW pewag winner profilift alpha	24-27
PLBW pewag winner profilift beta	28-31
PLGW pewag winner profilift gamma	32-35
PLGW-SN pewag winner profilift gamma supreme ring nut	36-37
PLDW pewag winner profilift delta	40-43
PLZW pewag winner profilift zeta	44-45
AOR pewag lashing point	46
RGS pewag eyebolt	47
PLGWI pewag winner profilift gamma inox	48-50
pewag lifting points: Calculation of the thread length	51





pewag PLAW alpha



pewag winner profilift alpha. Simply the best.

This lifting point is 360° rotatable. The load ring is rotatable across a wide range and can be positioned at any required angle due to its replaceable and patented spring. The hexagonal special screw is also replaceable and secured against loss. The PLAW pewag winner profilift alpha screw is made from 10.9 grade material, 100% crack-tested, covered with a chromate VI-free protection agent against corrosion and marked with the working load limit and thread size.

The pewag winner profilift alpha screw is able to withstand a 4-fold safety factor against breakage in all directions and every single lifting point is marked with an individual serial number. pewag winner profilift alpha is available with metric or UNC-thread. The versions with metric thread are also available with customised thread lengths. All working load limits, categorised by type of application, the number of legs and angle of inclination, are contained in a table that forms an integral part of the operating manual included with each lifting point.

Optionally also available with peTAG (NFC chip) or PIP (colour marking).



PLAW 0,3 t - 1,5 t and PLAW 4 t / 13



PLAW 2,5 t - 20 t



PLAW 2,5 t - 20 t

Permitted usage

For working load limits in the permitted directions of pull, please refer to the working load limit table.

Non-permitted usage

During assembly, ensure that improper loading does not arise due to any of the following factors:

- Direction of pull is obstructed
- Direction of pull is not within the indicated area
- Loading ring rests against edges or surfaces

The loading ring must be placed in the direction of pull before loading – do not turn under load! For additional details and information, please refer to the full operating manual.

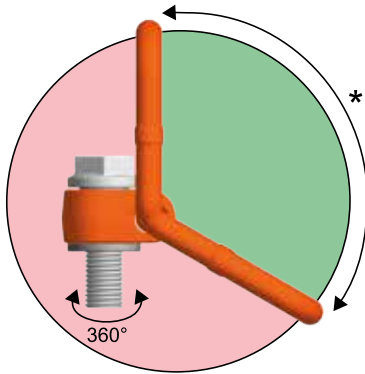

Permissible load directions



Non-permissible load directions



Improper loading as loading ring rests against edges or surfaces

pewag PLAW alpha

Lashing type
Number of legs
Angle of inclination

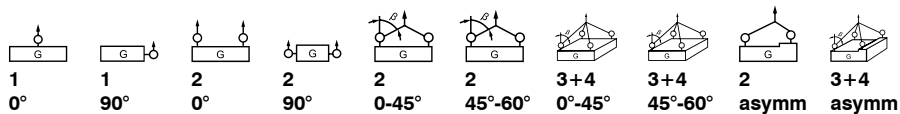

Code	Thread [mm]	Torque [Nm]	Working load limit [kg]									
			1	1	2	2	2	2	3+4	3+4	2	3+4
PLAW 0,3 t	M8	35	300	300	600	600	400	300	600	400	300	300
PLAW 0,63 t	M10	70	630	630	1.260	1.260	850	630	1.300	900	630	630
PLAW 1 t	M12	120	1.000	1.000	2.000	2.000	1.400	1.000	2.100	1.500	1.000	1.000
PLAW 1,5 t	M16	150	1.500	1.500	3.000	3.000	2.100	1.500	3.100	2.200	1.500	1.500
PLAW 2,5 t	M20	170	2.500	2.500	5.000	5.000	3.500	2.500	5.300	3.700	2.500	2.500
PLAW 4 t (/13)	M24	400	4.000	4.000	8.000	8.000	5.600	4.000	8.400	6.000	4.000	4.000
PLAW 6 t	M30	500	6.000	6.000	12.000	12.000	8.500	6.000	12.700	9.000	6.000	6.000
PLAW 7 t	M36	700	7.000	7.000	14.000	14.000	9.800	7.000	14.800	10.500	7.000	7.000
PLAW 8 t	M36	800	8.000	8.000	16.000	16.000	11.300	8.000	16.900	12.000	8.000	8.000
PLAW 10 t	M42	1.500	10.000	10.000	20.000	20.000	14.000	10.000	21.000	15.000	10.000	10.000
PLAW 15 t	M42	1.500	15.000	15.000	30.000	30.000	21.000	15.000	31.500	22.500	15.000	15.000
PLAW 20 t	M48	2.000	20.000	20.000	40.000	40.000	28.000	20.000	42.000	30.000	20.000	20.000

Code	Thread [inch]	Torque [ft-lbs]	Working load limit [lbs]									
			1	1	2	2	2	2	3+4	3+4	2	3+4
PLAW U5/16	5/16"-18	25,8	660	660	1.300	1.300	920	660	1.350	950	660	660
PLAW U 3/8	3/8"-16	52	1.400	1.400	2.800	2.800	1.960	1.400	2.940	2.100	1.400	1.400
PLAW U 1/2	1/2"-13	89	2.200	2.200	4.400	4.400	3.000	2.200	4.600	3.300	2.200	2.200
PLAW U 5/8	5/8"-11	110	3.300	3.300	6.600	6.600	4.600	3.300	6.800	4.800	3.300	3.300
PLAW U 3/4	3/4"-10	125	4.400	4.400	8.800	8.800	6.000	4.400	9.200	6.500	4.400	4.400
PLAW U 1	1"-8	295	8.800	8.800	17.600	17.600	12.300	8.800	18.400	13.200	8.800	8.800
PLAW U 1 1/4	1 1/4"-7	369	13.200	13.200	26.400	26.400	18.700	13.200	27.800	19.800	13.200	13.200
PLAW U 1 1/2	1 1/2"-6	590	17.000	17.000	35.200	35.200	24.800	17.000	37.300	26.400	17.000	17.000
PLAW U 1 3/4	1 3/4"-5	740	22.000	22.000	44.000	44.000	30.000	22.000	45.000	33.000	22.000	22.000

Safety factor 4:1

Straight pull 0°	Lateral load direction „permitted“ (ring is aligned) 90°
Higher working load limits for loading vertically to welding level (column "0°" in the working load limit table)	Higher working load limits for loading vertically to welding level (column "90°" in the working load limit table)

Code	Thread [mm]	Working load limit [kg]	a [mm]	b [mm]	c [mm]	d [mm]	e [mm]	g [mm]	h [mm]	k [mm]	n [mm]	n max [mm]	⊘ [mm]	⊘ [mm]	Weight [kg/unit]
PLAW 0,3 t	M8	300	45	67	40	11	41	95	36	55	20	150	10	24	0,17
PLAW 0,63 t	M10	630	45	67	40	11	41	95	36	55	20	150	10	24	0,58
PLAW 1 t	M12	1.000	45	67	40	11	41	95	36	55	20 ¹⁾	170	10	24	0,26
PLAW 1,5 t	M16	1.500	45	67	40	11	41	95	36	55	24 ¹⁾	260	10	24	0,52
PLAW 2,5 t	M20	2.500	54	81	50	13	55	112	50	67	33	335	8	24	1,10
PLAW 4 t (/13)	M24	4.000	54	87	50	17	67	142	45	70	36	361	14	36	1,60
PLAW 6 t	M30	6.000	68	108	60	20	68	148	55	85	45	360	14	36	2,50
PLAW 7 t	M36	7.000	75	115	67	20	65	143	60	100	55	374	27	-	3,30
PLAW 8 t	M36	8.000	93	147	85	27	87	188	85	120	55	365	19	41	3,80
PLAW 10 t	M42	10.000	93	147	85	27	87	188	85	120	65	365	19	41	4,80
PLAW 15 t	M42	15.000	115	181	105	33	108	246	106	150	63	340	19	55	12,00
PLAW 20 t	M48	20.000	115	181	105	33	108	246	106	150	73	340	19	55	12,30

¹⁾ Previously 33 mm

Code	Thread [inch]	Working load limit [lbs]	a [inch]	b [inch]	c [inch]	d [inch]	e [inch]	g [inch]	h [inch]	k [inch]	n [inch]	n max [inch]	⊘ [inch]	⊘ [inch]	Weight [lbs/ pcs.]
PLAW U5/16	5/16"-18	660	1,77	2,64	1,57	0,43	1,61	3,72	1,42	2,17	0,79	-	7/32"	-	1,30
PLAW U 3/8	3/8"-16	1.400	1,77	2,64	1,57	0,43	1,61	3,72	1,42	2,17	0,79	-	3/8"	15/16"	1,30
PLAW U 1/2	1/2"-13	2.200	1,77	2,64	1,57	0,43	1,61	3,72	1,42	2,17	1,30	-	3/8"	15/16"	1,32
PLAW U 5/8	5/8"-11	3.300	1,77	2,64	1,57	0,43	1,61	3,72	1,42	2,17	1,30	-	3/8"	15/16"	1,39
PLAW U 3/4	3/4"-10	4.400	2,13	3,19	1,97	0,51	2,24	4,21	1,97	2,64	1,30	-	9/16"	-	2,40
PLAW U 1	1"-8	8.800	2,95	4,53	2,64	0,79	2,68	5,63	2,64	3,94	1,42	-	3/4"	-	6,60
PLAW U 1 1/4	1 1/4"-7	13.200	2,95	4,53	2,64	0,79	2,68	5,63	2,64	3,94	1,93	-	7/8"	-	6,80
PLAW U 1 1/2	1 1/2"-6	17.000	3,66	5,79	3,35	1,06	3,43	7,40	3,35	4,72	2,09	-	1"	-	13,40
PLAW U 1 3/4	1 3/4"-5	22.000	3,66	5,79	3,35	1,06	3,43	7,40	3,35	4,72	2,44	-	1 1/4"	-	14,10

Safety factor 4:1

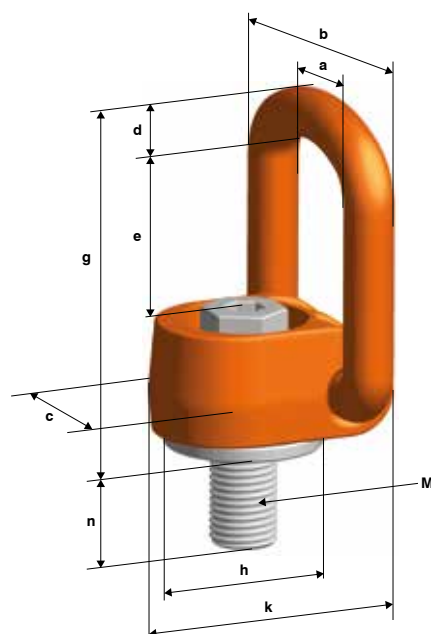

pewag PLBW beta

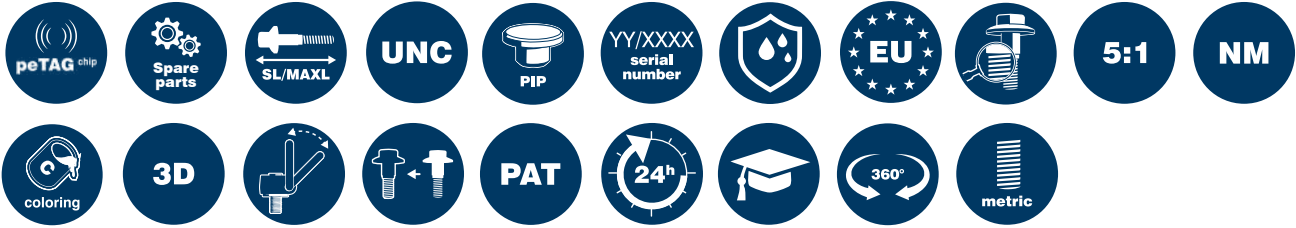

pewag winner profilift beta. Five-fold safety.

This is another lifting point that is 360° rotatable. The load ring is movable to an angle of 180° and can be positioned at any required angle due to its replaceable and patented spring. In the permitted applications, this lifting point offers five-fold safety.

In accordance with the pewag standard, each lifting point comes with its own individual serial number. The lifting points are marked with the admissible working load limit for the most unfavourable application mode, allowing for an increased working load limit in case of vertical loads. The hexagonal special screw made from grade 10.9 material is also interchangeable and secured against loss. The screw is 100% crack-tested as well as covered with a chromate VI-free protection against corrosion and marked with the working load limit and thread size. It can be tightened with a hexagon wrench or spanner wrench.

pewag winner profilift beta is available with a metric as well as a UNC thread and with customised thread lengths.

All working load limits, categorised by lashing type, number of legs and angle of inclination are contained in a table that forms an integral part of the operating manual included with each lifting point.

Optionally also available with peTAG (NFC chip) or PIP (colour marking).

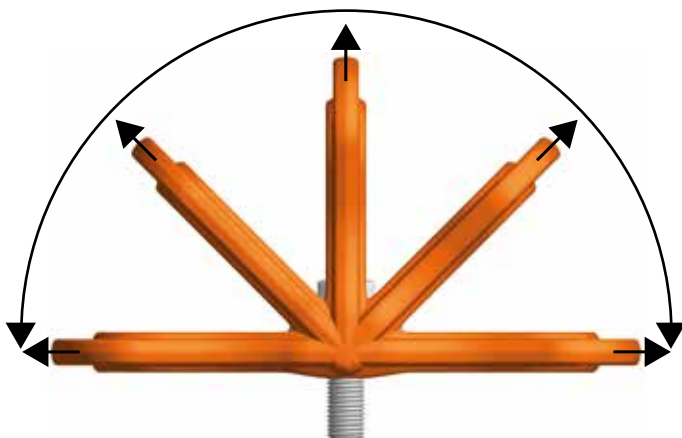

Permitted load directions



Permitted load directions

Permitted usage

Please refer to the working load limit tables for working load limits in the permitted directions of pull.

Non-permitted usage

During assembly, ensure that improper loading cannot arise due to any of the following factors:

- Direction of pull is obstructed
- Direction of pull is not within the indicated area
- Loading ring rests against edges or loads.

The load ring must be placed in the direction of pull before loading – do not turn under load! For additional details and information, please refer to the full operating manual.

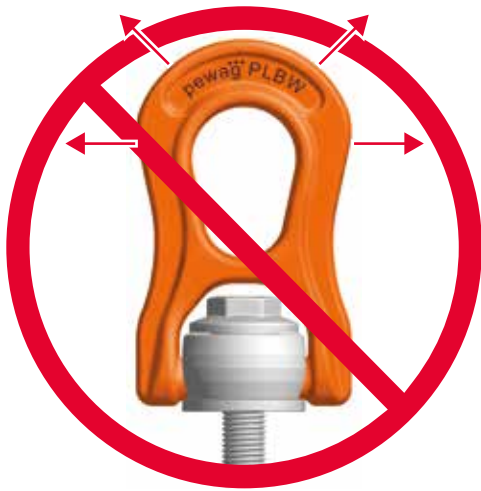

Non-permitted load directions



Improper loading as loading ring rests against edges or surfaces

pewag PLBW beta

Lashing type
Number of legs
Angle of inclination

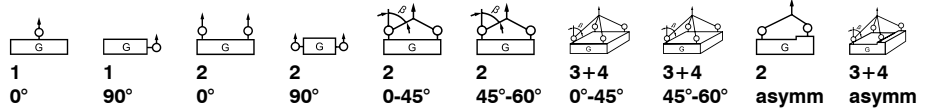

Code	Thread [mm]	Torque [Nm]	Working load limit [kg]									
			1	1	2	2	2	2	3+4	3+4	2	3+4
PLBW 0,3 t	M8	6	500	300	1.000	600	400	300	600	450	300	300
PLBW 0,6 t	M10	10	1.000	600	2.000	1.200	800	600	1.300	900	600	600
PLBW 1 t	M12	15	1.300	1.000	2.600	2.000	1.400	1.000	2.100	1.500	1.000	1.000
PLBW 1,3 t	M14	30	2.000	1.300	4.000	2.600	1.800	1.300	2.700	1.900	1.300	1.300
PLBW 1,6 t	M16	50	2.500	1.600	5.000	3.200	2.200	1.600	3.400	2.400	1.600	1.600
PLBW 2 t	M18	70	3.000	2.000	6.000	4.000	2.800	2.000	4.200	3.000	2.000	2.000
PLBW 2,5 t	M20	100	3.500	2.500	7.000	5.000	3.500	2.500	5.300	3.700	2.500	2.500
PLBW 3 t	M22	120	4.500	3.000	9.000	6.000	4.200	3.000	6.300	4.500	3.000	3.000
PLBW 4 t	M24	160	5.500	4.000	11.000	8.000	5.600	4.000	8.400	6.000	4.000	4.000
PLBW 5 t	M27	200	6.500	5.000	13.000	10.000	7.000	5.000	10.500	7.500	5.000	5.000
PLBW 6,3 t	M30	250	7.000	6.300	14.000	12.600	8.800	6.300	13.200	9.400	6.300	6.300
PLBW 8 t	M33	270	9.000	8.000	18.000	16.000	11.000	8.000	16.500	12.000	8.000	8.000
PLBW 10 t	M36	320	11.000	10.000	22.000	20.000	14.000	10.000	21.000	15.000	10.000	10.000
PLBW 12,5 t	M42	400	13.500	12.500	27.000	25.000	17.500	12.500	26.300	18.700	12.500	12.500
PLBW 15 t	M48	600	16.000	15.000	32.000	30.000	21.000	15.000	32.000	22.500	15.000	15.000

Code	Thread [inch]	Torque [ft-lbs]	Working load limit [lbs]									
			1	1	2	2	2	2	3+4	3+4	2	3+4
PLBW U 5/16	5/16"-18	4,50	1.100	660	2.200	1.320	900	660	1.400	900	660	660
PLBW U 3/8	3/8"-16	7,50	2.200	1.300	4.400	2.600	1.800	1.300	2.700	1.900	1.300	1.300
PLBW U 7/16	7/16"-14	11	2.800	2.200	5.600	4.400	3.000	2.200	4.600	3.300	2.200	2.200
PLBW U 1/2	1/2"-13	11	2.800	2.200	5.600	4.400	3.000	2.200	4.600	3.300	2.200	2.200
PLBW U 9/16	9/16"-12	22	4.400	3.000	8.800	6.000	4.200	3.000	6.300	4.500	3.000	3.000
PLBW U 5/8	5/8"-11	37	5.500	3.500	11.000	7.000	4.900	3.500	7.300	5.200	3.500	3.500
PLBW U 3/4	3/4"-10	74	6.600	5.500	13.200	11.000	7.700	5.500	11.500	8.200	5.500	5.500
PLBW U 7/8 ¹⁾	7/8"-9	118	12.000	8.800	24.000	17.600	12.300	8.800	18.500	13.200	8.800	8.800
PLBW U 1 ¹⁾	1"-8	148	13.000	11.000	26.000	22.000	15.400	11.000	23.000	16.500	11.000	11.000
PLBW U 1 1/8 ¹⁾	1 1/8"-7	185	14.300	13.500	28.600	27.000	18.900	13.500	28.300	20.200	13.500	13.500
PLBW U 1 1/4 ¹⁾	1 1/4"-7	200	19.800	17.500	39.600	35.000	24.500	17.500	36.700	26.200	17.500	17.500
PLBW U 1 3/8 ¹⁾	1 3/8"-6	236	24.000	22.000	48.000	44.000	30.800	22.000	46.200	33.000	22.000	22.000
PLBW U 1 1/2 ¹⁾	1 1/2"-6	295	25.000	24.000	50.000	48.000	33.600	24.000	50.400	36.000	24.000	24.000

Safety factor 5:1
¹⁾ Safety factor 4:1

Straight pull 0°	Lateral load direction „permitted“ (ring is aligned) 90°	Lateral load direction “not permitted”
Higher working load limits for loading along the screw axis (column "0°" in the working load limit table)	Higher working load limits for loading vertically to the screw axis (column "90°" in the working load limit table)	Application not permitted due to unstable conditions. The ring could turn suddenly while under load - high risk for load and/or persons!

Code	Thread [mm]	Working load limit [kg]	a [mm]	b [mm]	c [mm]	e [mm]	f [mm]	g [mm]	h [mm]	n [mm]	n max [mm]	⊘ [mm]	⊣ [mm]	Weight [kg/unit]
PLBW 0,3 t	M8	300	29	56	30	38	18	27	94	13	80	8	15	0,31
PLBW 0,6 t	M10	600	29	56	30	38	18	27	94	15	100	8	15	0,35
PLBW 1 t	M12	1.000	29	56	30	38	18	27	94	17	180	8	15	0,37
PLBW 1,3 t	M14	1.300	43	79	45	55	25	38	138	22	220	10	24	1,03
PLBW 1,6 t	M16	1.600	43	79	45	55	25	38	138	24	260	10	24	1,04
PLBW 2 t	M18	2.000	43	79	45	55	25	38	138	27	295	10	24	1,07
PLBW 2,5 t	M20	2.500	43	79	45	55	25	38	138	30	335	10	24	1,08
PLBW 3 t	M22	3.000	64	118	68	85	38	58	209	33	355	14	36	3,50
PLBW 4 t	M24	4.000	64	118	68	85	38	58	209	36	355	14	36	3,60
PLBW 5 t	M27	5.000	64	118	68	85	38	58	209	40	355	14	36	3,60
PLBW 6,3 t	M30	6.300	64	118	68	85	38	58	209	45	355	14	36	3,70
PLBW 8 t	M33	8.000	106	188	108	132	60	91	331	54	328	19	55	14,30
PLBW 10 t	M36	10.000	106	188	108	132	60	91	331	59	328	19	55	14,40
PLBW 12,5 t	M42	12.500	106	188	108	132	60	91	331	69	328	19	55	14,70
PLBW 15 t	M48	15.000	106	188	108	132	60	91	331	74	328	19	55	15,00

Code	Thread [inch]	Working load limit [lbs]	a [inch]	b [inch]	c [inch]	e [inch]	f [inch]	g [inch]	h [inch]	n [inch]	n max [inch]	⊘ [inch]	⊣ [inch]	Weight [lbs/pcs.]
PLBW U 5/16	5/16"-18	660	1,14	2,20	1,18	1,50	0,71	1,06	3,70	0,51	-	5/16"	5/8"	0,71
PLBW U 3/8	3/8"-16	1.300	1,14	2,20	1,18	1,50	0,71	1,06	3,70	0,59	-	5/16"	5/8"	0,73
PLBW U 7/16	7/16"-14	2.200	1,14	2,20	1,18	1,50	0,71	1,06	3,70	0,67	-	5/16"	5/8"	0,75
PLBW U 1/2	1/2"-13	2.200	1,14	2,20	1,18	1,50	0,71	1,06	3,70	0,67	-	5/16"	5/8"	0,77
PLBW U 9/16	9/16"-12	3.000	1,69	3,11	1,77	2,17	0,98	1,50	5,43	0,87	-	5/16"	1"	2,27
PLBW U 5/8	5/8"-11	3.500	1,69	3,11	1,77	2,17	0,98	1,50	5,43	0,94	-	5/16"	1"	2,29
PLBW U 3/4	3/4"-10	5.500	1,69	3,11	1,77	2,17	0,98	1,50	5,43	1,18	-	5/16"	1"	2,38
PLBW U 7/8 ¹⁾	7/8"-9	8.800	2,52	4,65	2,68	3,35	1,50	2,28	8,23	1,42	-	9/16"	1 3/8"	7,78
PLBW U 1 ¹⁾	1"-8	11.000	2,52	4,65	2,68	3,35	1,50	2,28	8,23	1,57	-	9/16"	1 3/8"	7,89
PLBW U 1 1/8 ¹⁾	1 1/8"-7	13.500	2,52	4,65	2,68	3,35	1,50	2,28	8,23	1,77	-	9/16"	1 3/8"	8,07
PLBW U 1 1/4 ¹⁾	1 1/4"-7	17.500	4,17	7,40	4,25	5,20	2,36	3,58	13,03	2,13	-	3/4"	2 3/16"	32,00
PLBW U 1 3/8 ¹⁾	1 3/8"-6	22.000	4,17	7,40	4,25	5,20	2,36	3,58	13,03	2,32	-	3/4"	2 3/16"	32,20
PLBW U 1 1/2 ¹⁾	1 1/2"-6	24.000	4,17	7,40	4,25	5,20	2,36	3,58	13,03	2,72	-	3/4"	2 3/16"	14,70

Safety factor 5:1

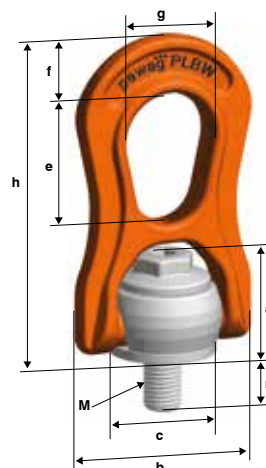
¹⁾ Safety factor 4:1

pewag PLGW gamma



pewag winner profilift gamma eyebolt. Close to perfection.

The PLGW gamma lifting point was developed and manufactured according to the latest standards. Simply tighten by hand, then align in the load direction - a system that is ideally suited for frequent assembly/disassembly. This patented system has been a great success from the word go and offers unsurpassed ease-of-use.

The eyebolt is 360° rotatable, comes with an interchangeable special screw that is 100% crack-tested as well as chrome VI-free finish-protection against corrosion and is marked with the working load limit and the thread size. The surface of the load is protected by an integrated sleeve. The batch number displayed on all load-bearing parts such as the eye and screws as well as the serial number make identification, traceability and performance of mandatory, regular inspections easier than ever.

PLGW supreme: tool-free assembly and disassembly

Latch in position 1: The latch is not in direct contact with the screw (fig. PLGW supreme rotatable)

- The latch is held in place with a patented spring.
- The eyebolt is rotatable.

Latch in position 2: The latch is in direct contact with the screw (fig. PLGW supreme assembly/disassembly)

- The latch is held in place with a patented spring.
- Eyebolt is not rotatable i.e. the fastening torque is transmitted to the screw and thus the eyebolt can be (re)assembled.

PLGW basic:

A simplified alternative is the pewag PLGW pewag winner profilift gamma basic. Offering the same benefits as the pewag PLGW supreme in terms of measurement, working load limit and application, the pewag PLGW basic differs solely when it comes to assembly: Mounting and removing requires the use of a hexagon Allen wrench. A special Allen key for the sizes M8 - M20 is available upon request.

Optionally also available with peTAG (NFC chip) or PIP (colour marking). The pewag winner profilift gamma is also available with a metric or UNC thread.



PLGW supreme –tool-free handling



PLGW supreme rotatable



PLGW supreme assembly/disassembly



PLGW basic - assembly with tools

Permitted usage

For working load limits in the permitted directions of pull, please refer to the working load limit table. Adjust the lifting point in the permitted load direction before loading.

- Loadable with a 4-fold safety factor against breakage in all directions

Non-permitted usage

During assembly, ensure that improper loading does not arise due to any of the following factors:

- Direction of pull is obstructed
- Direction of pull is not within the indicated area
- Loading ring rests against edges or loads
- Assembly with additional tools (e.g. extension) is not permitted

For additional details and information, please refer to the full operating manual..

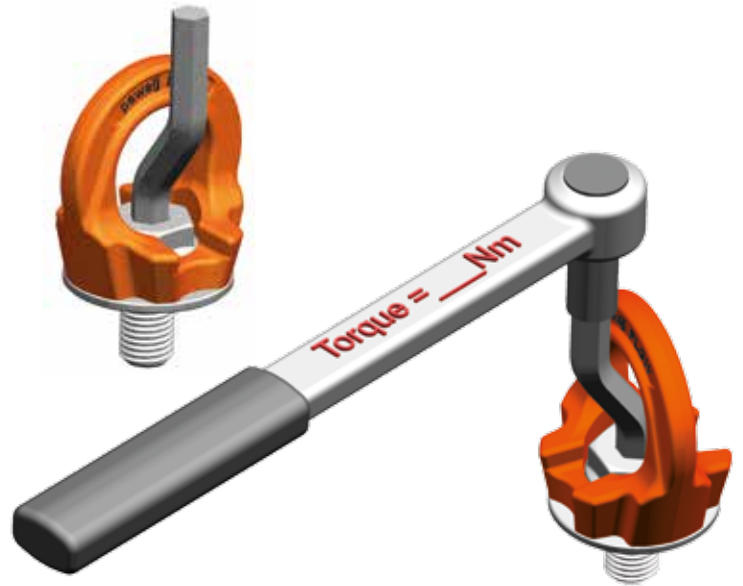

Special Allen key - available as a spare part (see page 73)



Permitted load directions

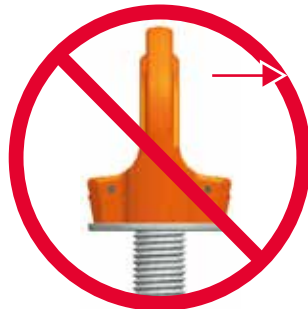

Non-permitted load directions

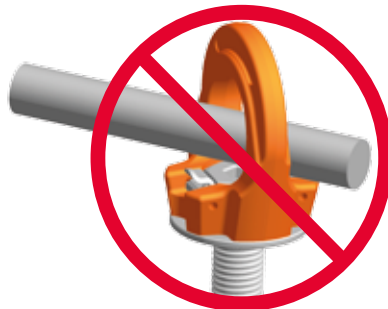

No additional tools permitted



PLGW assembly video / PLGIS

pewag PLGW gamma

Lashing type
Number of legs
Angle of inclination

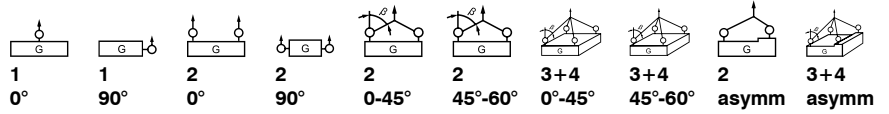

Code	Thread [mm]	Torque [Nm]	Working load limit [kg]									
			1	2	3	4	5	6	7	8	9	10
PLGW 0,3 t	M8	Simply tighten by hand	1.000	300	2.000	600	420	300	630	450	300	300
PLGW 0,5 t	M10		1.500	500	3.000	1.000	700	500	1.060	750	500	500
PLGW 0,7 t	M12		2.000	700	4.000	1.400	980	700	1.480	1.050	700	700
PLGW 1,5 t	M16		4.000	1.500	8.000	3.000	2.100	1.500	3.180	2.200	1.500	1.500
PLGW 2,3 t	M20		5.000	2.300	10.000	4.600	3.200	2.300	4.800	3.400	2.300	2.300
PLGW 3,2 t	M24		6.500	3.200	13.000	6.400	4.500	3.200	6.700	4.800	3.200	3.200
PLGW 4,9 t	M30		12.000	4.900	24.000	9.800	6.900	4.900	10.300	7.300	4.900	4.900
PLGW 7 t	M36		15.000	7.000	30.000	14.000	9.800	7.000	14.800	10.500	7.000	7.000
PLGW 9 t	M42		22.000	9.000	44.000	18.000	12.600	9.000	19.000	13.500	9.000	9.000
PLGW 12 t	M48		30.000	12.000	60.000	24.000	16.900	12.000	25.400	18.000	12.000	12.000

Code	Thread [inch]	Torque [ft-lbs]	Working load limit [lbs]									
			1	2	3	4	5	6	7	8	9	10
PLGW U 3/8	3/8"-16	Simply tighten by hand	2.400	1.100	4.800	2.200	1.500	1.100	2.200	1.500	1.100	1.100
PLGW U 1/2	1/2"-13		4.400	1.500	8.800	3.000	2.200	1.500	3.000	2.200	1.500	1.500
PLGW U 5/8	5/8"-11		8.800	3.300	17.600	6.000	4.600	3.300	6.600	4.800	3.300	3.300
PLGW U 3/4	3/4"-10		9.900	4.400	19.800	8.800	6.100	4.400	9.200	6.600	4.400	4.400
PLGW U 1	1"-8		11.000	6.600	22.000	13.200	9.200	6.600	13.600	9.900	6.600	6.600
PLGW U 1 1/4	1 1/4"-7		22.000	8.800	44.000	17.600	12.300	8.800	18.000	13.200	8.800	8.800
PLGW U 1 1/2	1 1/2"-6		33.000	15.400	66.000	30.800	21.500	15.400	32.300	23.100	15.400	15.400
PLGW U 1 3/4	1 3/4"-5		40.000	19.800	80.000	39.600	27.700	19.800	41.500	29.700	19.800	19.800

Safety factor 4:1

Straight pull 0°	Lateral load direction „permitted“ (ring is aligned) 90°	Lateral load direction “not permitted”
Higher working load limits for loading along the screw axis (column "0°" in the working load limit table)	Nominal working load limit for loading vertically to the screw axis (column "90°" in the working load limit table)	Application not permitted due to unstable conditions. The ring could turn suddenly while under load - high risk for load and/or persons!

Code	Thread [mm]	Working load limit [kg]	a [mm]	b [mm]	c [mm]	d [mm]	e [mm]	f [mm]	n [mm]	n max [mm]	⊘ [mm]	Weight [kg/unit]
PLGW 0,3 t	M8	300	25	45	10	27	53	35	15	90	6	0,20
PLGW 0,5 t	M10	500	25	45	10	27	53	35	15	160	6	0,05
PLGW 0,7 t	M12	700	30	55	12	32	63	43	20	160	8	0,32
PLGW 1,5 t	M16	1.500	35	64	14	36	70	50	25	160	10	0,48
PLGW 2,3 t	M20	2.300	40	73	16	41	81	54	30	160	12	0,58
PLGW 3,2 t	M24	3.200	50	86	18	50	93	69	35	-	14	1,10
PLGW 4,9 t	M30	4.900	60	110	25	60	114	90	45	-	17	2,20
PLGW 7 t	M36	7.000	70	132	31	70	136	108	55	-	19	3,80
PLGW 9 t	M42	9.000	80	152	36	72	153	126	65	-	22	5,70
PLGW 12 t	M48	12.000	95	179	42	88	179	148	75	-	24	8,90

Code	Thread [inch]	Working load limit [lbs]	a [inch]	b [inch]	c [inch]	d [inch]	e [inch]	f [inch]	n [inch]	n max [inch]	⊘ [inch]	Weight [lbs/pc.]
PLGW U 3/8	3/8"-16	1.100	0,98	1,77	0,39	1,06	2,09	1,38	0,59	-	1/4"	0,44
PLGW U 1/2	1/2"-13	1.500	1,18	2,17	0,47	1,26	2,48	1,69	0,79	-	5/16"	0,71
PLGW U 5/8	5/8"-11	3.300	1,38	2,52	0,55	1,42	2,76	1,97	0,98	-	3/8"	0,99
PLGW U 3/4	3/4"-10	4.400	1,57	2,87	0,63	1,61	3,19	2,13	1,18	-	1/2"	1,28
PLGW U 1	1"-8	6.600	1,97	3,39	0,71	1,97	3,66	2,72	1,38	-	9/16"	2,43
PLGW U 1 1/4	1 1/4"-7	8.800	2,36	4,33	0,98	2,36	4,49	3,54	1,77	-	5/8"	4,63
PLGW U 1 1/2	1 1/2"-6	15.400	2,76	5,20	1,22	2,76	5,35	4,25	2,17	-	7/8"	8,38
PLGW U 1 3/4	1 3/4"-5	19.800	3,15	5,98	1,42	2,83	6,02	4,96	2,56	-	1"	12,57

Safety factor 4:1

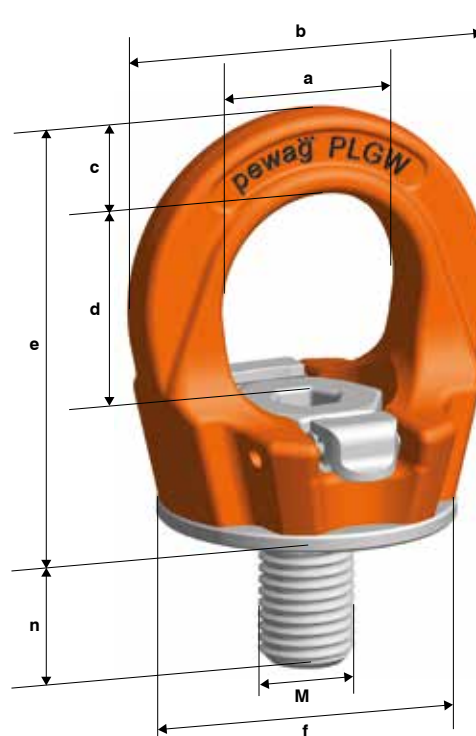

pewag PLGW-SN gamma



pewag winner profilift gamma supreme ring nut Globally unique.

This ring nut works on the principle of tool-free assembly, making it unique worldwide. It is the logical continuation of the successful pewag PLGW supreme eyebolt and is used on loads that come with a threaded bolt instead of a thread.

Alternatively, the PLGW-SN supreme lifting point may be attached in a through-hole using a standard screw, which has the additional advantage of being able to use the same lifting point with different material thicknesses. This method requires just crack-tested screws (strength category 10.9) of different lengths.

For additional details and information, please refer to the full operating manual.

Other benefits of the PLGW-SN pewag winner profilift gamma supreme lifting point:

- No tools are required for assembly or disassembly
- Saves time especially with frequent assembly/disassembly
- The lifting point is rotatable (may be set in the load direction) and loadable in all directions.

Optionally also available with peTAG (NFC chip) or PIP (colour marking).

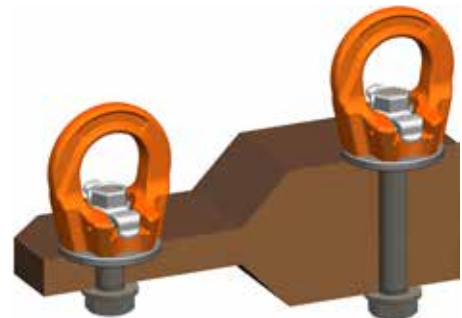

Different material thicknesses



Existing threaded bolts



pewag PLGW SN
Eye nut 3D

Permitted usage

For working load limits in the permitted directions of pull, please refer to the working load limit table. Adjust the lifting point in the permitted load direction before loading.

- Loadable with a 4-fold safety under break in all directions

Non-permitted usage

During assembly, ensure that improper loading does not arise due to any of the following factors:

- Direction of pull is obstructed
- Direction of pull is not within the indicated area
- Loading ring rests against edges or loads

Each lifting point comes with an individual serial number.

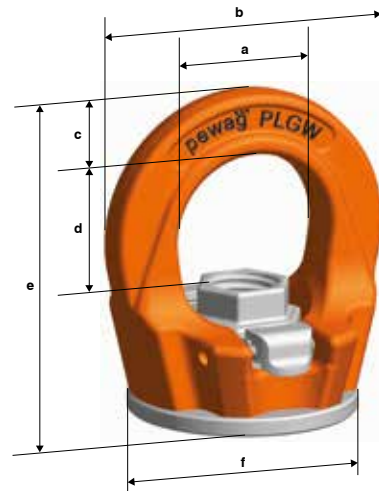

For the corresponding values, see tables with technical data



Permissible load directions



Use of PLGW or PLGW-SN

Lashing type
Number of legs
Angle of inclination

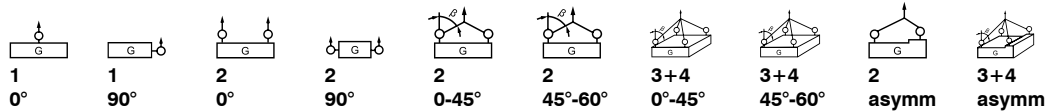



Code	Thread [mm]	Working load limit [kg]									
PLGW-SN 0,3 t	M8	1.000	300	2.000	600	400	300	600	400	300	300
PLGW-SN 0,5 t	M10	1.500	500	3.000	1.000	700	500	1.000	700	500	500
PLGW-SN 0,7 t	M12	2.000	700	4.000	1.400	1.000	700	1.400	1.000	700	700
PLGW-SN 1,5 t	M16	4.000	1.500	8.000	3.000	2.100	1.500	3.000	2.200	1.500	1.500
PLGW-SN 2,3 t	M20	5.000	2.300	10.000	4.600	3.200	2.300	4.800	3.400	2.300	2.300
PLGW-SN 3,5 t	M24	6.500	3.500	13.000	7.000	4.900	3.500	7.400	5.200	3.500	3.500
PLGW-SN 4,9 t	M30	12.000	4.900	24.000	9.000	6.900	4.900	10.300	7.300	4.900	4.900

Code	Thread [mm]	Working load limit [kg]	a [mm]	b [mm]	c [mm]	d [mm]	e [mm]	f [mm]	⊘ [mm]	Weight [kg/unit]
PLGW-SN 0,3 t	M8	300	25	45	10	21	55	35	12	0,17
PLGW-SN 0,5 t	M10	500	25	45	10	21	55	35	12	0,17
PLGW-SN 0,7 t	M12	700	30	55	12	25	65	43	14	0,28
PLGW-SN 1,5 t	M16	1.500	35	64	14	29	72	50	19	0,42
PLGW-SN 2,3 t	M20	2.300	40	73	16	34	82	54	22	0,50
PLGW-SN 3,5 t	M24	3.500	50	86	18	40	95	69	27	1,00
PLGW-SN 4,9 t	M30	4.900	60	110	25	47	115	90	36	1,90

Safety factor 4:1

PLGW in comparison: Points in its favour.

- Significantly higher working load limit with the same thread size
- Rotatable by 360°, thus adjustable in the load direction
- Four-fold safety factor against breakage in all directions
- 100 % crack-tested screw

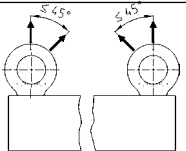
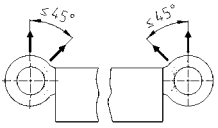
PLGW eye bolts and/or PLGW-SN eye nut			Eye bolt DIN 580 and/or eye nut DIN 582				
							
	Product	PLGW (SN)	DIN 580 / DIN 582		PLGW (SN)	DIN 580 / DIN 582	
	Thread size	M12	M12	1*) 2*)	M36	M36	1*) 2*)
	Nominal working load limit	0,7 t	0,34 t		7 t	4,6 t	
	WLL	2 t	0,34 t	M30	15 t	4,6 t	M64
	Breaking load limit	8 t	2,04 t		60 t	27,6 t	
	WLL (< 45°)	0,7 t	0,24 t	M20	7 t	3,3 t	M56
	Breaking load limit (< 45°)	2,8 t	1,44 t		28 t	19,8 t	
	WLL (< 45° lateral)	0,7 t	0,17 t	M24	7 t	2,3 t	M64
	Breaking load limit (< 45° lateral)	2,8 t	1,02 t		28 t	13,8 t	

1*) Refers to the size DIN 580 required to carry the same load as the pewag profilift gamma (in the appropriate direction of loading).

Mode of application: Single-leg, straight pull, load = 2 t, required thread size pewag PLGW: M12, required thread size eye bolt DIN 580: M30

Mode of application: Multi-leg sling

2*) The working load limit of DIN 580 applies only if the screws are screwed in completely and rest on the load with the entire contact surface. Those can always be aligned in the tensile direction. Since it is very likely that at least one screw is loaded in the wrong direction, pewag recommends the adjustable eye bolts PLGW, which may always be aligned with the direction of pull.



Size comparison PLGW M12 – DIN 580-M30



Learning services for
education and
training

pewag academy

Product and technology training, e-learning, blended learning

The individual courses impart comprehensive knowledge on pewag products and technologies.

These courses provide added value for companies and participants, since they can be used or acknowledged within the framework of training prescribed by law.



“
**Knowledge
for you**
”



Intermedial teaching material

Visualisation of training content with videos and animations



Anytime

Independent of time and place

Unrestricted access to training content (videos, articles etc.) in the respective area of training on the pewag academy portal



Anywhere

Multimedia teaching content is also available on smartphone or tablet



pewag PLDW delta

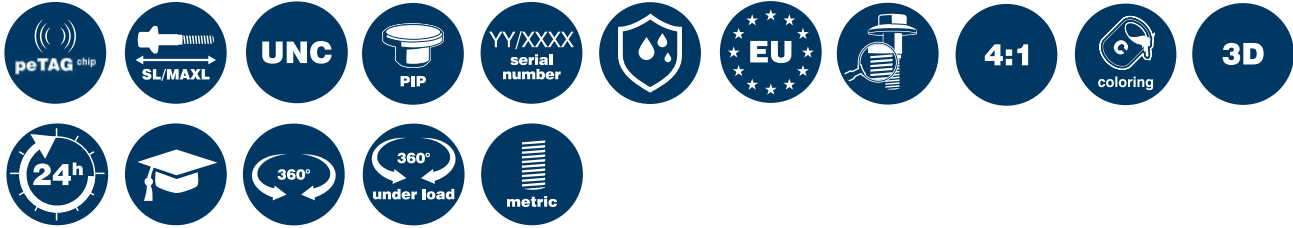

pewag winner profilift delta. Rotatable even under load.

This lifting point comes with a ball bearing and is rotatable by 360° even under load. The high-strength lifting eye is movable by 180°. The special screw is 100% crack-tested, protected against corrosion and marked with the working load limit and thread size. In addition, each lifting point is marked with its own individual serial number. The lifting eye comes with a ring and is wide enough to accommodate even larger hooks.

All working load limits, categorised by lashing type, number of legs and angle of inclination are contained in a table that forms an integral part of the operating manual included with each lifting point. The pewag winner profilift delta lifting points are marked with the admissible working load limit for the most unfavourable application mode, with four-fold safety against break in all directions. In addition, working load limits are higher in case of vertical loading. pewag winner profilift delta is available with a metric or UNC thread, up to a thread size of M100 or a working load limit of 60,000kg.

Optionally also available with peTAG (NFC chip) or PIP (colour marking).



Permitted usage

For working load limits in the permitted directions of pull, please refer to the working load limit table.

Non-permitted usage

During assembly, ensure that improper loading does not arise due to any of the following factors:

- Direction of pull is obstructed
- Direction of pull is not within the indicated area
- Loading ring rests against edges or loads

The lifting points are ball-bearing mounted. However, to prevent the ring from jamming, it is recommended to align it in the permitted and required direction of pull prior to loading (fig. Permitted direction of loading). This is particularly relevant when lifting loads with multi-leg chain slings. If the ring is not aligned (non-permitted loading acc. to fig. 2), the ring holder could suddenly become loose, causing a significant risk to loads and operators.

The full operating manual contains further details and information on safe usage.

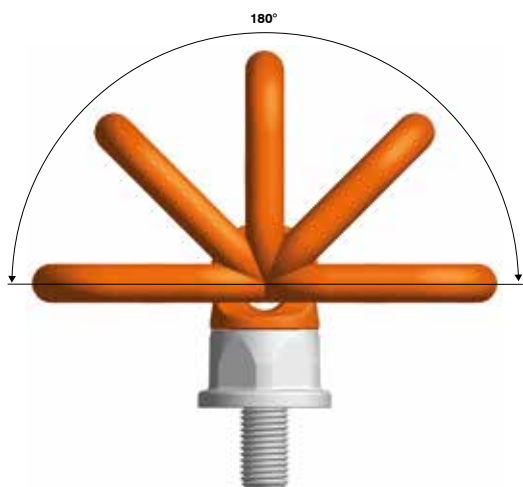

Permissible load directions



Ball-bearing mounted lifting point

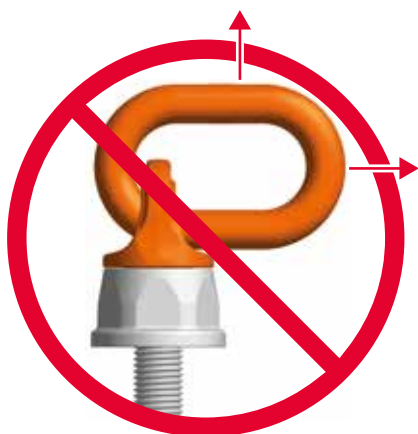

Non-permissible load directions

pewag PLDW delta

Lashing type
Number of legs
Angle of inclination

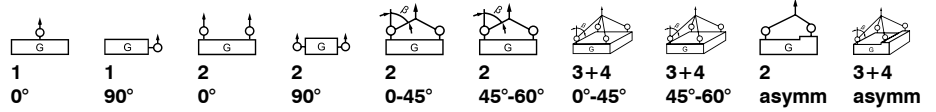

Code	Thread [mm]	Torque [Nm]	Working load limit [kg]									
			600	300	1.200	600	400	300	600	400	300	300
PLDW 0,3 t	M8	10	600	300	1.200	600	400	300	600	400	300	300
PLDW 0,5 t	M10	10	1.200	500	2.400	1.000	700	500	1.000	750	500	500
PLDW 0,7 t	M12	15	1.800	700	3.600	1.400	950	700	1.400	1.000	700	700
PLDW 1 t *	M14	25	2.400	1.000	4.800	2.000	1.400	1.000	2.100	1.500	1.000	1.000
PLDW 1,5 t	M16	30	2.800	1.500	5.600	3.000	2.100	1.500	3.100	2.200	1.500	1.500
PLDW 2,5 t	M20	80	5.000	2.500	10.000	5.000	3.500	2.500	5.300	3.500	2.500	2.500
PLDW 4 t	M24	150	7.000	4.000	14.000	8.000	5.500	4.000	8.400	6.000	4.000	4.000
PLDW 5,3 t	M30	230	7.000	5.300	14.000	10.600	7.400	5.300	11.200	7.900	5.300	5.300
PLDW 6,7 t	M30	230	10.000	6.700	20.000	13.400	9.400	6.700	14.200	10.000	6.700	6.700
PLDW 8 t	M36	450	12.500	8.000	25.000	16.000	11.200	8.000	16.800	12.000	8.000	8.000
PLDW 10 t	M42	600	16.000	10.000	32.000	20.000	14.000	10.000	21.000	15.000	10.000	10.000
PLDW 12 t	M45	600	16.000	12.000	32.000	24.000	16.900	12.000	25.400	18.000	12.000	12.000
PLDW 13 t	M48	600	16.000	13.000	32.000	26.000	18.300	13.000	27.500	19.500	13.000	13.000
PLDW 13 t	M52	600	16.000	13.000	32.000	26.000	18.300	13.000	27.500	19.500	13.000	13.000
PLDW 24 t	M56	800	28.000	24.000	56.000	48.000	33.900	24.000	50.900	36.000	24.000	24.000
PLDW 25 t	M64	800	28.000	25.000	56.000	50.000	35.300	25.000	53.000	37.500	25.000	25.000
PLDW 40 t	M72	1.200	60.000	40.000	120.000	80.000	56.500	40.000	84.800	60.000	40.000	40.000
PLDW 45 t	M80	1.400	60.000	45.000	120.000	90.000	63.600	45.000	95.400	67.500	45.000	45.000
PLDW 55 t	M90	1.500	60.000	55.000	120.000	110.000	77.700	55.000	116.600	82.500	55.000	55.000
PLDW 55 t	M100	1.600	60.000	55.000	120.000	110.000	77.700	55.000	116.600	82.500	55.000	55.000

* Custom designs available upon request only

Code	Thread [inch]	Torque [ft-lbs]	Working load limit [lbs]									
			2.640	1.100	5.290	2.200	1.500	1.100	2.330	1.650	1.100	1.100
PLDW U 3/8	3/8"-16	7,50	2.640	1.100	5.290	2.200	1.500	1.100	2.330	1.650	1.100	1.100
PLDW U 1/2	1/2"-13	11	3.900	1.500	7.900	3.000	2.100	1.500	3.200	2.300	1.500	1.500
PLDW U 5/8	5/8"-11	22	6.100	3.300	12.300	6.600	4.600	3.300	7.000	4.900	3.300	3.300
PLDW U 3/4	3/4"-10	60	8.800	4.400	17.600	8.800	6.200	4.400	9.300	6.600	4.400	4.400
PLDW U 1	1"-8	110	15.400	8.800	30.800	17.600	12.400	8.800	18.700	13.200	8.800	8.800
PLDW U 1 1/4	1 1/4"-7	170	22.000	14.700	44.000	29.500	20.800	14.700	31.300	22.100	14.700	14.700
PLDW U 1 1/2	1 1/2"-6	330	27.500	17.600	55.100	35.200	24.600	17.600	37.400	26.400	17.600	17.600
PLDW U 1 3/4	1 3/4"-5	440	35.200	22.000	70.500	44.000	31.100	22.000	46.700	33.000	22.000	22.000
PLDW U 2	2"-4.5	440	35.200	27.500	70.500	55.100	38.900	27.500	58.400	41.300	27.500	27.500
PLDW U 2 1/2	2 1/2"-4	600	61.700	39.600	123.400	79.300	56.100	39.600	84.100	59.500	39.600	39.600

Safety factor 4:1

<p>Straight pull 0°</p>	<p>Lateral load direction „permitted“ (ring is aligned) 90°</p>	<p>Lateral load direction not permitted (ring is not aligned)</p>
<p>Higher working load limits for loading along the screw axis (column "0°" in the working load limit table)</p>	<p>Nominal working load limit for loading vertically to the screw axis (column "90°" in the working load limit table)</p>	<p>Application not permitted due to unstable conditions. The ring could turn suddenly while under load - high risk for load and/or persons!</p>

Code	Thread [mm]	Working load limit [kg]	a [mm]	b [mm]	c [mm]	d [mm]	e [mm]	n [mm]	n max [mm]	⊥ [mm]	Weight [kg/unit]
PLDW 0,3 t	M8	300	30	38	54	13	38	20	100	34	0,45
PLDW 0,5 t	M10	500	30	38	54	13	38	20	180	34	0,45
PLDW 0,7 t	M12	700	35	48	54	13	38	22	200	34	0,48
PLDW 1 t	M14	1.000	35	48	54	13	38	22	200	34	0,49
PLDW 1,5 t	M16	1.500	35	48	54	13	38	33	250	34	0,51
PLDW 2,5 t	M20	2.500	35	55	75	16	55	33	250	46	1,05
PLDW 4 t	M24	4.000	40	66	82	17	63	40	300	50	1,50
PLDW 5,3 t	M30	5.300	40	66	82	17	63	35	300	50	1,50
PLDW 6,7 t	M30	6.700	50	70	92	23	72	40	300	60	2,49
PLDW 8 t	M36	8.000	50	91	120	23	92	55	300	75	4,30
PLDW 10 t	M42	10.000	65	91	120	27	92	60	300	75	5,10
PLDW 12 t	M45	12.000	65	91	120	27	92	68	-	75	5,20
PLDW 13 t	M48	13.000	65	116	120	27	92	68	300	75	5,4
PLDW 13 t	M52	13.000	65	116	120	27	92	68	-	75	5,40
PLDW 24 t	M56	24.000	70	105	154	33	110	84	300	95	10,20
PLDW 25 t	M64	25.000	70	105	154	33	110	96	300	95	11,00
PLDW 40 t	M72	40.000	90	130	213	45	170	110	500	145	29,00
PLDW 45 t	M80	45.000	90	130	213	45	170	120	500	145	30,00
PLDW 55 t	M90	55.000	90	130	213	45	170	135	500	145	32,00
PLDW 55 t	M100	55.000	90	130	213	45	170	150	500	145	35,00

Code	Thread [inch]	Working load limit [lbs]	a [inch]	b [inch]	c [inch]	d [inch]	e [inch]	n [inch]	n max [inch]	⊥ [inch]	Weight [lbs/pcs.]
PLDW U 3/8	3/8"-16	1.100	1,18	1,50	2,13	0,51	1,50	0,59	-	1,34	1,00
PLDW U 1/2	1/2"-13	1.500	1,38	1,89	2,13	0,51	1,50	0,79	-	1,34	1,06
PLDW U 5/8	5/8"-11	3.300	1,38	1,89	2,13	0,51	1,50	0,98	-	1,34	1,10
PLDW U 3/4	3/4"-10	4.400	1,38	2,17	2,95	0,63	2,17	1,18	-	1,81	2,43
PLDW U 1	1"-8	8.800	1,57	2,60	3,23	0,67	2,48	1,57	-	1,97	3,30
PLDW U 1 1/4	1 1/4"-7	14.700	1,97	2,76	3,62	0,91	2,83	1,77	-	2,36	5,70
PLDW U 1 1/2	1 1/2"-6	17.600	1,97	3,58	4,72	0,91	3,62	2,17	-	2,95	9,50
PLDW U 1 3/4	1 3/4"-5	22.000	2,56	3,58	4,72	1,06	3,62	2,36	-	2,95	11,20
PLDW U 2	2"-4.5	27.500	2,56	4,57	4,72	1,06	3,62	2,68	-	2,95	11,90
PLDW U 2 1/2	2 1/2"-4	39.600	2,76	4,13	6,06	1,30	4,33	3,78	-	3,74	22,40

Safety factor 4:1

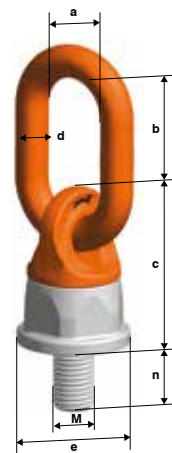

pewag PLZW zeta



pewag winner profilift lifting point PLZW zeta. Disassembled in no time.

Thanks to its innovative design, the pewag winner profilift lifting point PLZW zeta may be assembled and disassembled without the use of tools (applies up to thread size M24). The PLZW zeta therefore makes it possible to directly attach closed lifting equipment such as eye sling hooks or rope loops, without having to use additional shackles.

The latest addition to the pewag lifting point portfolio comes with a five-fold safety factor against breakage, is rotatable by 360° and may be loaded in all directions. The individual serial number and the batch number make it possible to clearly identify the lifting point at all times. The PLZW zeta protects the surface of the load from damage thanks to an integrated sleeve. The screw is 100% crack-tested, comes with a chromate VI-free protection against corrosion and is marked with the working load limit, thread size and torque. The PLZW zeta is mounted in the desired position using a tool.

Optionally also available with peTAG (NFC chip) or PIP (colour marking).

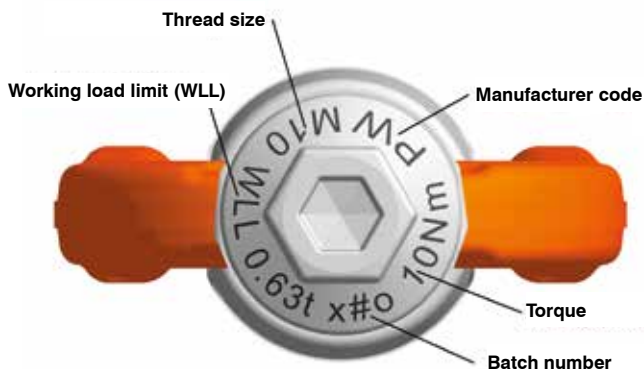
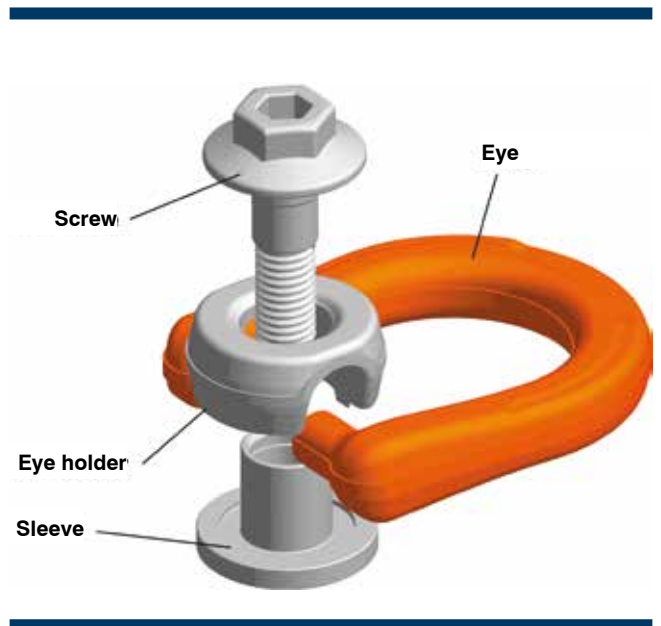

Marking on the screw

Lashing type
Number of legs
Angle of inclination

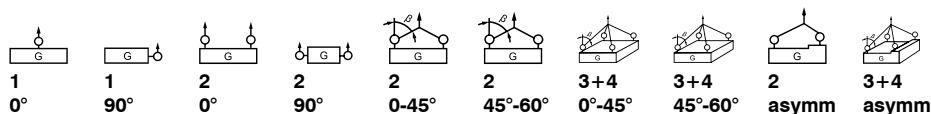

Code	Thread [mm]	Torque [Nm]	Working load limit [kg]									
			800	400	1.600	800	560	400	840	600	400	400
PLZW 0,4 t*	M8	10	800	400	1.600	800	560	400	840	600	400	400
PLZW 0,63 t*	M10	10	1.100	630	2.200	1.260	890	630	1.330	940	630	630
PLZW 0,95 t*	M12	15	1.100	950	2.200	1.900	1.340	950	2.010	1.420	950	950
PLZW 1,8 t*	M16	50	2.900	1.800	5.800	3.600	2.540	1.800	3.810	2.700	1.800	1.800
PLZW 2,5 t*	M20	100	2.900	2.500	5.800	5.000	3.530	2.500	5.300	3.750	2.500	2.500
PLZW 4 t*	M24	160	6.500	4.000	13.000	8.000	5.650	4.000	8.480	6.000	4.000	4.000
PLZW 6,3 t	M30	250	6.500	6.300	13.000	12.600	8.900	6.300	13.360	9.450	6.300	6.300
PLZW 10 t	M36	320	15.000	10.000	30.000	20.000	14.100	10.000	21.200	15.000	10.000	10.000
PLZW 13 t	M42	400	15.000	13.000	30.000	26.000	18.300	13.000	27.500	19.500	13.000	13.000
PLZW 15 t	M48	600	15.000	15.000	30.000	30.000	21.200	15.000	31.800	22.500	15.000	15.000

Code	Thread [mm]	Working load limit [kg]	a [mm]	b [mm]	c [mm]	d [mm]	e [mm]	f [mm]	g [mm]	n [mm]	n max [mm]	∅ [mm]	↖ [mm]	Weight [kg/unit]
PLZW 0,4 t*	M8	400	40	64	29	14	34	30	77	12	80	8	15	0,30
PLZW 0,63 t*	M10	630	40	64	29	14	34	30	77	15	100	8	15	0,30
PLZW 0,95 t*	M12	950	40	64	29	14	34	30	77	18	180	8	15	0,30
PLZW 1,8 t*	M16	1.800	50	83	43	19	50	45	112	24	260	10	24	0,90
PLZW 2,5 t*	M20	2.500	50	83	43	19	50	45	112	30	330	10	24	0,95
PLZW 4 t*	M24	4.000	70	121	64	28	69	68	161	36	355	14	36	2,80
PLZW 6,3 t	M30	6.300	70	121	64	28	69	68	161	45	355	14	36	3,00
PLZW 10 t	M36	10.000	110	183	106	38	114	108	259	59	328	19	55	10,80
PLZW 13 t	M42	13.000	110	183	106	38	114	108	259	69	328	19	55	11,10
PLZW 15 t	M48	15.000	110	183	106	38	114	108	259	74	328	19	55	11,20

Safety factor 5:1
*dismountable without tools

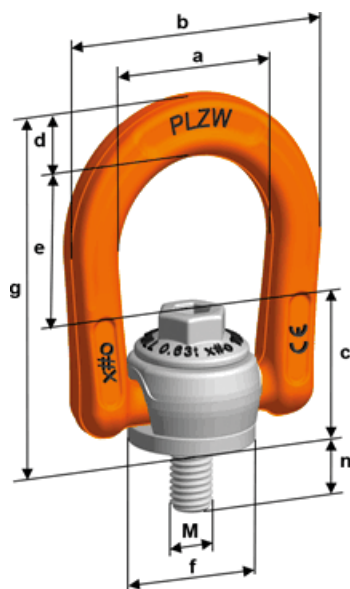

pewag winner profilift – lifting point PLZW zeta

pewag AOR lashing point



4:1



AOR lashing point.

When it comes to reliability, this lashing point won't be beaten. It is perfect for mounting machine parts or vehicle bodies as well as for the hanging of lifting and lashing gear.

Permitted usage

Please refer to the working load limit as stated in the inspection certificate and/or the working load limit table to ensure maximum safety for permitted applications.

Non-permitted usage

During assembly, ensure that improper loading does not arise due to any of the following factors:

- Direction of pull is obstructed
- Direction of pull is not within the indicated area
- Loading ring rests against edges or loads

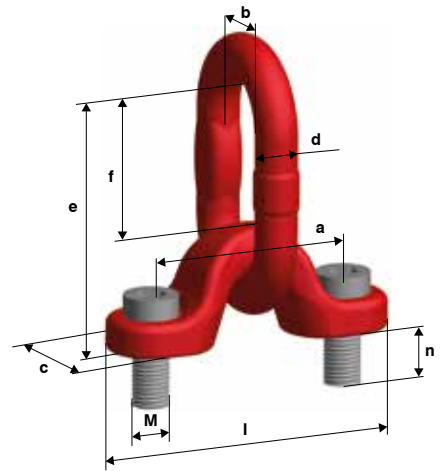

Lashing type

Number of legs

Angle of inclination



1

0°



1

90°



2

0°



2

90°



2

0-45°



2

45°-60°



3+4

0°-45°



3+4

45°-60°



2

asymm



3+4

asymm

Code	Thread [mm]	Torque [Nm]	Working load limit [kg]									
			1	1	2	2	2	2	3+4	3+4	2	3+4
AOR 10	M16	170	3.150	3.150	6.300	6.300	4.250	3.150	6.700	4.750	3.150	3.150
AOR 13	M20	350	5.300	5.300	10.600	10.600	7.500	5.300	11.200	8.000	5.300	5.300
AOR 16	M30	950	8.000	8.000	16.000	16.000	11.200	8.000	17.000	11.800	8.000	8.000
AOR 22	M36	1.900	15.000	15.000	30.000	30.000	21.200	15.000	31.500	22.400	15.000	15.000
AOR 26 ¹⁾	M42	2.100	21.200	21.200	42.400	42.400	30.000	21.200	45.000	31.500	21.200	21.200
AOR 28 ¹⁾	M45	2.400	25.000	25.000	50.000	50.000	33.500	25.000	50.000	37.500	25.000	25.000
AOR 32 ¹⁾	M56	3.200	31.500	31.500	63.000	63.000	45.000	31.500	67.000	47.500	31.500	31.500
AOR 34 ¹⁾	M56	3.200	36.000	36.000	72.000	72.000	50.000	36.000	75.000	53.000	36.000	36.000

Code	Thread [mm]	Working load limit [kg]	For chain Ø	a [mm]	b [mm]	c [mm]	d [mm]	e [mm]	f [mm]	l [mm]	n [mm]	Weight [kg/unit]
AOR 10	M16	3.150	10	90	40	38	18	112	57	130	25	1,41
AOR 13	M20	5.300	13	115	50	48	22	149	79	165	36	2,83
AOR 16	M30	8.000	16	150	65	62	26	183	93	212	50	5,78
AOR 22	M36	15.000	22	175	75	72	36	226	114	255	54	10,90
AOR 26 ¹⁾	M42	21.200	26	200	95	90	45	272	142	295	67	19,30
AOR 28 ¹⁾	M45	25.000	28	200	95	90	45	272	142	295	67	20,20
AOR 32 ¹⁾	M56	31.500	32	230	110	100	48	336	193	330	88	31,70
AOR 34 ¹⁾	M56	36.000	34	230	110	100	48	336	193	330	88	31,70

Safety factor 4:1

¹⁾ Not a stock item

pewag RGS eyebolt



4:1



toolfree



metric

RGS eyebolt.

This high-strength RGS eyebolt is the ideal for lifting machine parts. Eyebolts may only be tightened manually and are not suitable for diagonal pull. However, they cannot be beaten when it comes to quality.

Permitted usage

For working load limits in the permitted directions of pull (fig. Permitted usage), please refer to the working load limit table on the following pages.

Non-permitted usage

During assembly, ensure that improper loading cannot arise due to any of the following factors:

- Direction of pull is obstructed
- Direction of pull is not within the indicated area (fig. Non-permitted usage)

Please note that the RGS eyebolt may only be placed under load in the direction of pull! For all other lashing types, use the rotatable PLGW eyebolt or the rotatable lifting points PLAW, PLBW or PLDW.



Permitted usage

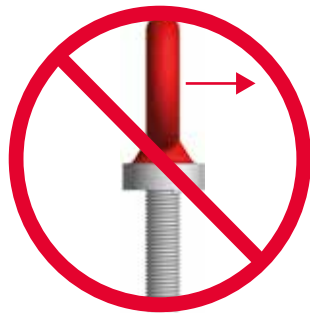

Non-permitted usage

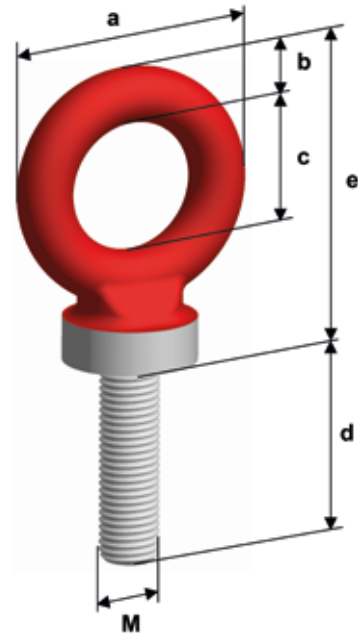

Code	Thread [mm]	Working load limit I-Strang 0° [kg]	Working load limit II-Strang 0° [kg]	a [mm]	b [mm]	c [mm]	d [mm]	e [mm]	Weight [kg/unit]
RGS 8	M8	400	800	34	7	20	24	44	0,05
RGS 10	M10	700	1.400	38	8	22	30	49	0,10
RGS 12	M12	1.000	2.000	47	10	26	36	59	0,14
RGS 14	M14	1.200	2.400	57	14	29	40	71	0,25
RGS 16	M16	1.500	3.000	65	14	35	55	79	0,36
RGS 20	M20	2.500	5.000	73	16	39	59	89	0,55
RGS 24	M24	4.000	8.000	95	20	54	84	114	1,12
RGS 30	M30	6.000	12.000	108	24	59	100	132	1,84
RGS 36	M36	8.000	16.000	118	25	67	118	137	2,44
RGS 42	M42	10.000	20.000	139	31	79	135	166	4,00
RGS 48	M48	18.000	36.000	181	43	97	150	208	8,20

Safety factor 4:1

Additional sizes available upon request!

pewag PLGWI gamma inox



pewag winner profilift lifting point PLGWI gamma inox. Rust-resistant ease of use.

Naturally, the PLGW lifting point is also available in a rust-resistant version – as the PLGWI eye bolt, offering all the tried-and-tested pewag advantages: Versatility when it comes to areas of application, accurately fitted measurements, optimised working load limits and unsurpassed ease-of-use. Please note that a hexagon Allen wrench is required as a tool for mounting and removal.

And the PLGWI offers even more than that:

The eyebolt is 360° rotatable, comes with an interchangeable special screw that is 100% crack-tested and is marked with the working load limit and the thread size!

An integrated sleeve protects the surface of the load. The batch number displayed on all load-bearing parts such as the eye and screws as well as the serial number make identification, traceability and performance of mandatory, regular inspections easier than ever.

Additional benefits of the PLGW inox lifting point:

- Extendable areas of application thanks to Duplex steel with heightened rust-resistance
- The PRE/N value that determines the alloy composition and thus also the level of corrosion-resistance, lies at approx. 34.

Optionally also available with peTAG (NFC chip) or PIP (colour marking).



PLGWI gamma inox M12, M16 - available as a "basic" version (tool for assembly required)



PLGWI gamma inox M20 – available in „basic“ version (tool for assembly required) and „supreme“ version (no tool required for assembly)

Permitted usage

For working load limits in the permitted directions of pull, please refer to the working load limit table.

- Adjust the lifting point in the permitted load direction before loading.
- Loadable with a 4-fold safety under break in all directions.

Non-permitted usage

During assembly, ensure that improper loading does not arise due to any of the following factors:

- Direction of pull is obstructed
- Direction of pull is not within the indicated area
- Loading ring rests against edges or loads.

For additional details and information, please refer to the full operating manual.

Each lifting point comes with an individual serial number.

For detailed information such as lashing type, number of legs, angle of inclination etc., please refer to the tables on the following two pages.



Permissible load directions

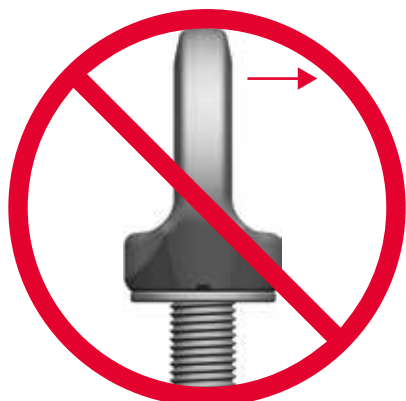

Non-permissible load directions

pewag PLGWI gamma inox

Lashing type
Number of legs
Angle of inclination

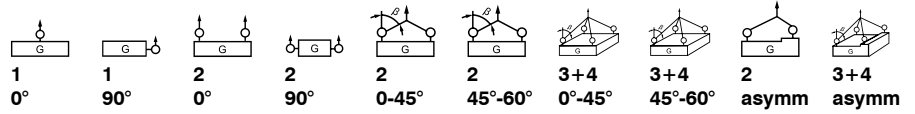

Code	Thread [mm]	Torque [Nm]	Working load limit [kg]									
			1.500	500	3.000	1.000	700	500	1.060	750	500	500
PLGWI 0,5 t	M12	25	1.500	500	3.000	1.000	700	500	1.060	750	500	500
PLGWI 1 t	M16	50	3.000	1.000	6.000	2.000	1.400	1.000	2.100	1.500	1.000	1.000
PLGWI 2 t	M20	115	3.800	2.000	7.600	4.000	2.800	2.000	4.200	3.000	2.000	2.000

Code	Thread [mm]	Working load limit [kg]	a [mm]	b [mm]	c [mm]	d [mm]	e [mm]	f [mm]	n [mm]	n max [mm]	Ø [mm]	Weight [kg/unit]
PLGWI 1 t	M16	1.000	35	64	14	35	67	35	24	160	10	0,36
PLGWI 2 t	M20	2.000	40	72	17	40	80	45	30	160	12	0,60

Safety factor 4:1

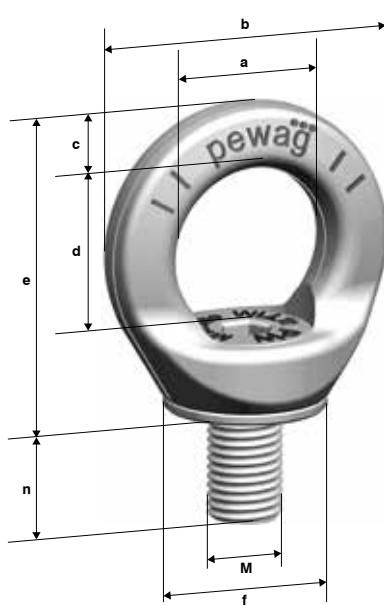

Marking on the screw + exploded view

Straight pull 0°	Lateral load direction „permitted“ (ring is aligned) 90°	Lateral load direction not permitted (ring is not aligned)
Higher working load limits for loading along the screw axis (column "0°" in the working load limit table)	Higher working load limits for loading vertically to the screw axis (column "90°" in the working load limit table)	Application not permitted due to unstable conditions. The ring could turn suddenly while under load - high risk for load and/or persons!

pewag profilift lifting points

As individual as your needs.

We supply your lifting point in a customer-specific length (CL) and maximum thread length (MAXL).

The set includes washer and screw nut.

The provided screw nuts are:

- 100 % crack-tested
- Strength category 10
- Manufactured according to DIN 980 V

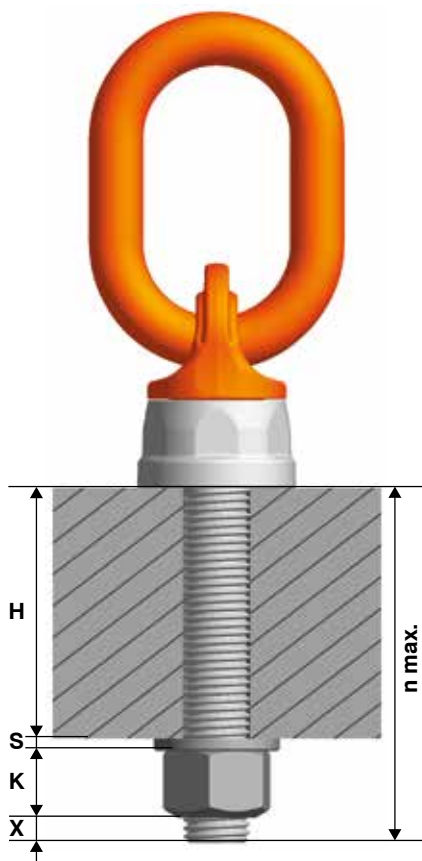

Calculation of the desired thread length (L):

$$L = H + S + K + X$$

H = Material height

S = Thickness of the washer

K = Height of the nut (Depending on the thread size of the screw)

X = Excess length of the screw (two-fold pitch)

L max. = n max.

Weldable hooks and lifting points

Product overview

Content

AHWH pewag winner weld-on hook	54
PLEW pewag winner profilift eta	56-57
PLE/N pewag profilift eta	58-59





pewag AHW



AWHW pewag winner weld-on hook. Welding mission accomplished.

This high-strength hook is particularly well suited for welding onto excavator bucket, spreader beams etc. Its outstanding features include a die-forged, tempered safety catch, making it extra-robust. As the safety catch locks into the tip of the hook, it provides excellent protection against lateral shifting.

The product is manufactured according to EN 1677-1 with a higher working load limit and comes with full operating and welding instructions that must be complied with at all times. The weld-on hook also has a CE marking. Replacing the SFGW-A safety catch set is easy and quick, without the need for special tools.

Optionally also available with peTAG (NFC chip) or PIP (colour marking).



Code	Working load limit [kg]	L [mm]	H [mm]	G [mm]	B [mm]	C [mm]	Weight [kg/unit]
AWHW 1,3	1.300	95	74	20	25	34	0,67
AWHW 3,8	3.800	132	106	26	35	40	1,40
AWHW 6,3	6.300	167	133	29	45	49	2,95
AWHW 10	10.000	175	136	29	50	49	4,02

Safety factor 4:1

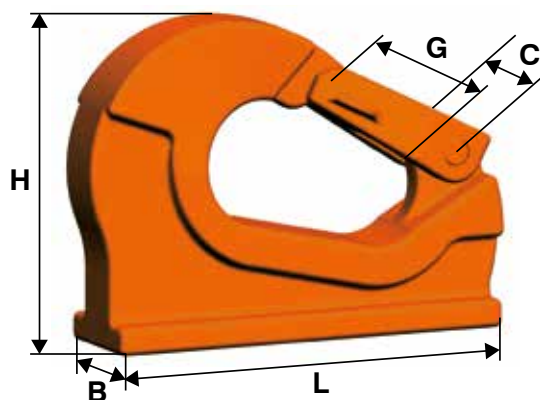

pewag – progressive, innovative and reliable

State-of-the-art technology for applications that carry some weight.

Our experience goes back centuries and makes pewag a company built on three principles: progression, innovation and reliability - in short, the factors that are reflected in every single one of our products.

pewag lifting points are products that stand out for their excellent compatibility with the globally successful pewag lifting chain programme and that make it even more versatile and flexible. Guaranteed ease-of-use when it comes to assembly and application is part of the pewag standard.

The weld-on lifting point PLEW complies with Machine Directive 2006/42/EC and is certified according to EN 1677-1 and BGR 500. Load capacities are clearly marked on the welding pad.

All welding operations comply with the provisions of DIN EN ISO 14341 and must be performed by welders with a valid qualification according to EN ISO 9606-1. The lifting points are delivered in individual packaging complete with user information and welding instructions.

Working load limits will vary according to the type of application, number of legs and angle of inclination and are listed in tables, which form an integral part of the detailed user manual corresponding to the Machine Safety Regulation 2010 and the Machine Directive. Each lifting point comes with a full operating manual.



PLEW marking



Operating manual



DGUV test certification

pewag PLEW eta



pewag winner profilift eta. Not one to break a promise.

The high-strength pewag winner profilift eta lifting points for welding onto machine components or vehicle bodies are ideal for the hanging of lifting and lashing parts. Thanks to the integrated spring, the ring is kept in any position that is required.

The PLEW has a higher nominal working load limit than the pewag PLE/N and is also suitable for straight-pull applications (preferred direction of loading) with higher working load limits (see operating manual). Grooves on the welding pad at 45° and 60° make it easier to recognise the permitted angle of inclination.

Each lifting point comes with an individual serial number. Also available with peTAG upon request.

All welding operations comply with the provisions of DIN EN ISO 14341 and must be performed by welders with a valid qualification according to EN ISO 9606-1.

The lifting points are delivered in individual packaging complete with user information and welding instructions.

Permitted usage

Working load limit as stated in the test certificate and/or the working load limit table, in the specified directions of pull.

Non-permitted usage

When choosing your configuration, check that there is no risk of improper loading due to any of the following factors:

- Direction of pull is obstructed
- Direction of pull is not within the indicated area
- Loading ring rests against edges or surfaces

Optionally also available with peTAG (NFC chip) or PIP (colour marking).

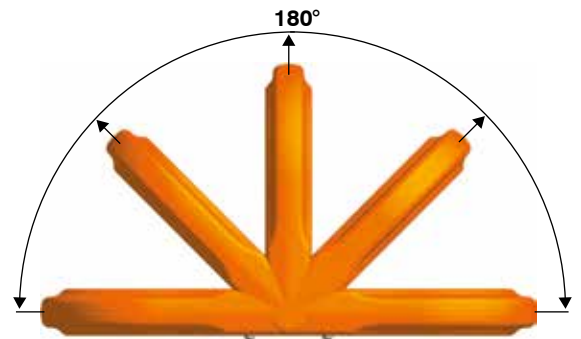

Permissible load directions

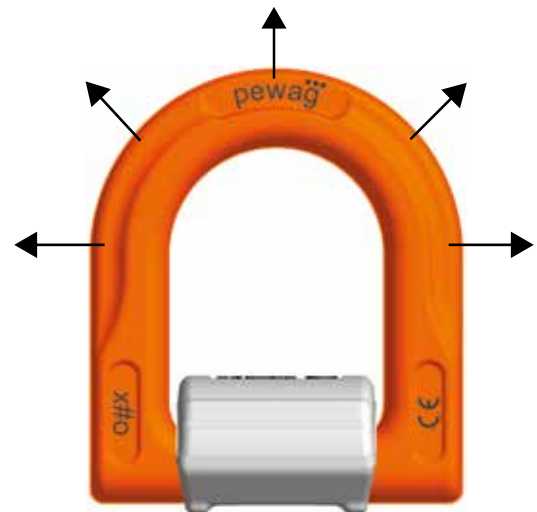

Permissible load directions



PLEW marking

Lashing type										
Number of legs	1	1	2	2	2	2	3+4	3+4	2	3+4
Angle of inclination	0°	90°	0°	90°	0-45°	45°-60°	0°-45°	45°-60°	asymm	asymm

Code	Working load limit [kg]									
PLEW 1,5 t	2.500	1.500	5.000	3.000	2.100	1.500	3.100	2.200	1.500	1.500
PLEW 2,5 t	4.000	2.500	8.000	5.000	3.500	2.500	5.300	3.700	2.500	2.500
PLEW 4 t	6.000	4.000	12.000	8.000	5.600	4.000	8.400	6.000	4.000	4.000
PLEW 6,7 t	10.000	6.700	20.000	13.400	9.400	6.700	14.200	10.000	6.700	6.700
PLEW 10 t	15.000	10.000	30.000	20.000	14.100	10.000	21.200	15.000	10.000	10.000
PLEW 19 t ¹⁾	25.000	19.000	50.000	38.000	26.800	19.000	40.300	28.500	19.000	19.000

Code	Working load limit [kg]	a [mm]	b [mm]	c [mm]	d [mm]	e [mm]	f [mm]	h [mm]	l [mm]	Weight [kg/unit]
PLEW 1,5 t	1.500	32	38	65	14	65	40	25	35	0,32
PLEW 2,5 t	2.500	37	44	75	16	76	47	28	41	0,50
PLEW 4 t	4.000	43	48	84	18	83	51	32	45	0,75
PLEW 6,7 t	6.700	58	60	107	24	108	64	44	56	1,70
PLEW 10 t	10.000	69	66	126	27	123	69	54	61	2,80
PLEW 19 t ¹⁾	19.000	92	95	171	38	168	100	68	89	6,50

¹⁾ Spring serves only as an aid during the welding process. With this type, the spring does not hold the in every position.
Safety factor 4:1

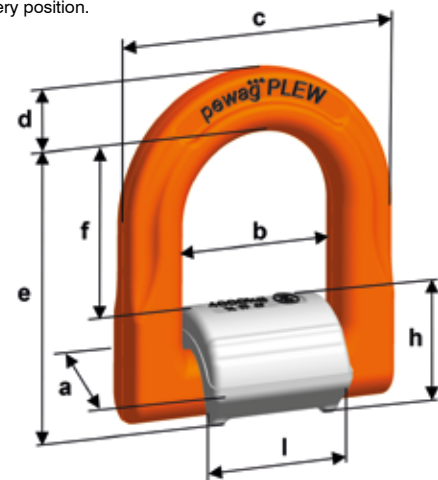

Straight pull 0°	Lateral load direction „permitted“ (ring is aligned) 90°	Lateral load direction “not permitted” (Ring not aligned)
Higher working load limits for loading vertically to welding level (column "0°" in the working load limit table)	Higher working load limits for loading vertically to welding level (column "90°" in the working load limit table)	Usage with nominal working load limit is possible. It is preferable to weld on the ring in such a way that it is loaded in the folding direction.

pewag PLE/N eta



PLE/N pewag profilift eta. Tried-and-tested for pull in every direction.

For welding onto machine components or vehicle bodies, special products are required that are ideal for attaching lifting and lashing devices. The PLE pewag profilift eta (grade 8) is such a product that has made a name for itself when it comes to high-strength eyebolts. An integrated spring keeps the ring in any position that is required. The product may be loaded in all directions.

Permitted usage

For working load limits in the permitted directions of pull (fig. Permitted usage), please refer to the working load limit table on the following pages.

Non-permitted usage

During assembly, ensure that improper loading does not arise due to any of the following factors:

- Direction of pull is obstructed
- Direction of pull is not within the indicated area
- Loading ring rests against edges or loads

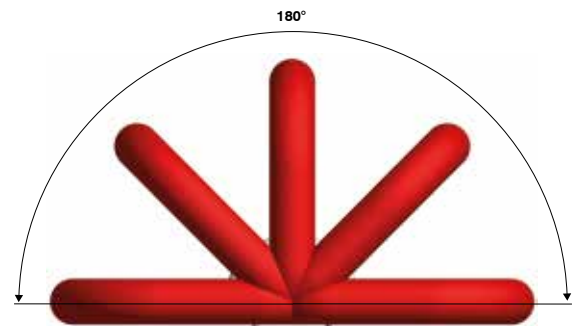

Permissible load directions



Lashing type										
Number of legs	1	1	2	2	2	2	3+4	3+4	2	3+4
Angle of inclination	0°	90°	0°	90°	0-45°	45°-60°	0°-45°	45°-60°	asymm	asymm

Code	Working load limit [kg]									
PLE/N 6	1.120	1.120	2.240	2.240	1.500	1.120	2.300	1.600	1.120	1.120
PLE/N 8	2.000	2.000	4.000	4.000	2.800	2.000	4.200	3.000	2.000	2.000
PLE/N 10	3.150	3.150	6.300	6.300	4.400	3.150	6.600	4.700	3.150	3.150
PLE/N 13	5.300	5.300	10.600	10.600	7.400	5.300	11.200	7.900	5.300	5.300
PLE/N 16	8.000	8.000	16.000	16.000	11.300	8.000	16.900	12.000	8.000	8.000
PLE/N 22	15.000	15.000	30.000	30.000	21.000	15.000	31.800	22.500	15.000	15.000

Code	Working load limit [kg]	a [mm]	b [mm]	c [mm]	d [mm]	e [mm]	f [mm]	h [mm]	l [mm]	Weight [kg/unit]
PLE/N 6	1.120	36	40	62	11	67	42	26	35	0,31
PLE/N 8	2.000	37	42	69	13	73	45	28	37	0,40
PLE/N 10	3.150	41	45	78	16,50	80	47	34	40	0,63
PLE/N 13	5.300	61	55	99	22	97	53	44	50	1,46
PLE/N 16	8.000	63	70	120	25	120	73	48	64	2,30
PLE/N 22	15.000	89	97	163	33	163	92	70	90	5,40

Safety factor 4:1

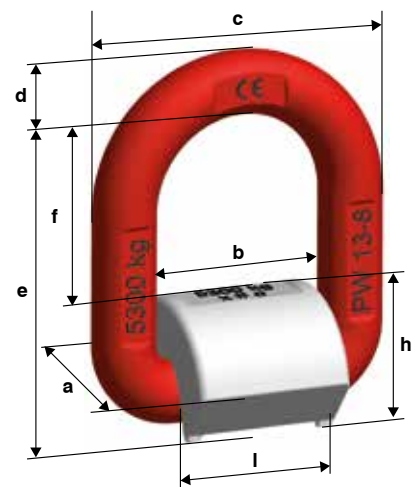

Straight pull 0°	Lateral load direction „permitted“ (ring is aligned) 90°	Lateral load direction “notD permitted” (ring not aligned)
Higher working load limits for loading vertically to welding level (column "0°" in the working load limit table)	Higher working load limits for loading vertically to welding level (column "90°" in the working load limit table)	Usage with nominal working load limit is possible. It is preferable to weld on the ring in such a way that it is loaded in the folding direction.

Anchorage devices for personal protection equipment

Product overview

Content

PLGW-PSA anchorage point for personal fall protection equipment	62-63
PLGWI-PSA anchorage point for personal fall protection equipment	64-65





pewag PLGW-PSA anchorage point

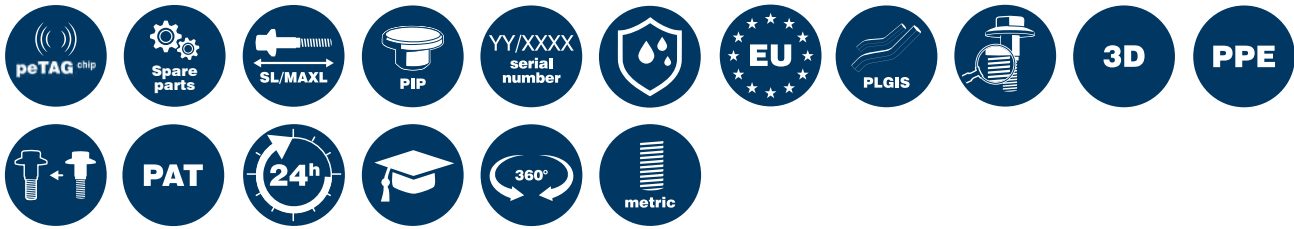

pewag winner prosecure gamma PSA anchorage point for personal fall protection equipment.

The pewag PLGW-PSA anchorage point is part of the anchorage system to which personal fall protection equipment may be attached. It was developed and tested in accordance with the stringent safety requirements for personal protection equipment according to EU Directive 89/686/EEC and already complies with the new EN795:2012 and CEN/TS 16415 standards. For all other details, please refer to the operating manual.

The PLGW-PSA is available in a “Basic” and “Supreme” version: The PLGW-PSA Basic is intended for permanent attachment to the anchorage system (e.g. tripod) and is mounted using a commercial Allen key. The PLGW-PSA Supreme is based on a patented system that allows for tool-free assembly and disassembly. The anchorage point is therefore easy to remove after usage. For detailed information on functionalities, please refer to the operating manual.

Thanks to the varnish in RAL 1003, both versions are also permitted for usage on stationary antennae systems (radio masts). The pewag PLGW-PSA anchorage point is available in size M12 (for 1 person), M16 and M20 (for max. 2 persons). All sizes are also available with a customised thread length.

Each anchorage point is marked with the thread size and the permissible number of persons as well as additional information. The individual serial number enables complete documentation of the required test procedures.

Optionally also available with peTAG (NFC chip) or PIP (colour marking).



pewag PLGW-PSA supreme for tool-free assembly



PLGW-PSA rotatable



PLGW-PSA dis-/assembly



Loadable on all sides



Marking on sleeve and screw
Part number and location of the identification details on the product

Code	Thread [mm]	Persons	a [mm]	b [mm]	c [mm]	d [mm]	e [mm]	f [mm]	n [mm]	n max [mm]	Hexagon [mm]	Weight [kg/unit]
PLGW PSA M12 ¹⁾	M12	1	30	55	12	32	63	55	20	160	8	0.30 / 0.42
PLGW PSA M16	M16	2	35	64	14	36	70	62	25	160	10	0.47 / 0.69
PLGW PSA M20	M20	2	40	73	16	41	81	66	30	160	12	0.60 / 0.95

¹⁾ Also available with US certification (complies with ANSI standard)

Information: The data in the weight column [kg/unit] refers to the standard length (n [mm]) and the maximum length (n max [mm]).



pewag PLGW-PSA basic

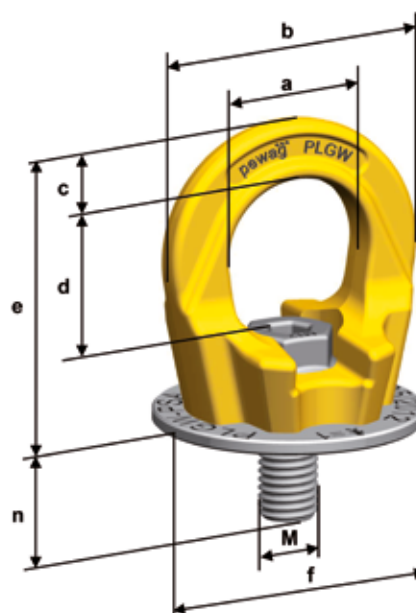

pewag PLGW-PSA basic

pewag PLGWI-PSA anchorage point



pewag winner prosecure gamma inox PSA

The pewag PLGWI-PSA anchorage point is part of the anchorage system to which personal fall protection equipment may be attached. It was developed and tested in accordance with the stringent safety requirements for personal protection equipment according to EU Directive 89/686/EEC and already complies with the new EN795:2012 and CEN/TS 16415 standards. For all other details, please refer to the operating manual.

Unlike the PLGW-PSA, the PLGWI-PSA is made from stainless material (INOX).

In addition, the screws are available in the desired and/or maximum lengths. The PLGWI-PSA may be mounted using a special pewag PLGW key or a standard Allen key.

Optionally also available with peTAG (NFC chip) or PIP (colour marking).



pewag PLGWI-PSA





Loadable on all sides



Marking on sleeve and screw.
Part number and location of the identification details on the product.

Code	Thread [mm]	Persons	a [mm]	b [mm]	c [mm]	d [mm]	e [mm]	f [mm]	n [mm]	n max [mm]	Hexagon [mm]	Weight [kg/unit]
PLGWI PSA M12	M12	1	30	55	12	30	59	40	18	160	8	0,23
PLGWI PSA M16	M16	2	35	64	14	35	67	45	23	160	10	0,37



pewag PLGWI-PSA



pewag PLGWI-PSA

pewag profilift lifting points

As individual as your needs.

Versatile, innovative, customer-specific.

We have the ideal solution for all areas of application.

Our portfolio includes screw-in and weldable lifting points, including models for manual and tool-free assembly with a safety factor of 4:1 or 5:1. All our lifting points come with a unique serial number for clear identification.

You decide which lifting point you need.

We are happy to advise you and help you find the right solution for your challenge.



The individual pewag solution for your challenge.

Based on your requirements, pewag develops safe and user-friendly, customised solutions.

- Whether there is a thread that needs adjusting (pipe thread, internal thread, locking pin etc.),
- solutions need to be customised (colour, reduced contact surface etc.)
- or welded adaptations are required (welded hook, attachment to mounting plate etc.)

we are looking forward to supporting you all the way.
Just get in touch!

liftingpoints@pewag.com



Spare parts

Product overview

Content

PLMS screw nut according to DIN 980 V (incl. washer)	70
PLGS screw PLGW	70
PLGES spare latches set	71
PLAS screw for PLAW	71
PLBS screw for PLBW	72
SFGW-A safety catch sets for AWHW	72
PLGIS Allen key set	73
ALP thread adapter	73
peTAG chip	74
PIP colour marking	74





pewag PLMS screw nut

This set is often used for pewag winner lifting points with customised lengths.
For sizes M8 to M48, these accessories are available as a set: The nut is crack-tested and manufactured according to DIN 980V in strength category 10. A washer completes the set.
From size M56, the nut is 1.5 times as long and is manufactured according to DIN 6331.

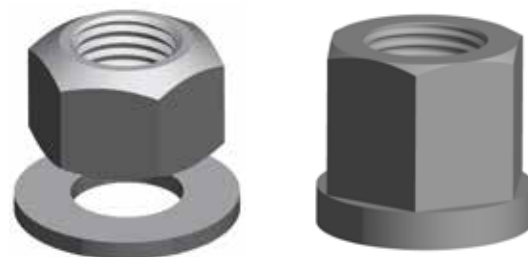

PLMS: M8 to M48

M56 and larger

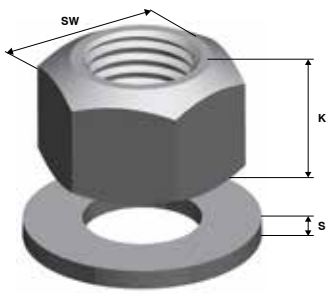
PLMS Screw nut	Code	Thread [mm]	Thread pitch P [mm]	SW [mm]	K [mm]	S [mm]	VPE [Unit]
	PLMS 8	M8	1,25	13	8	1,60	10
	PLMS 10	M10	1,50	17	10	2	10
	PLMS 12	M12	1,75	19	12	2,50	10
	PLMS 14	M14	2	22	14	3	10
	PLMS 16	M16	2	24	16	3	10
	PLMS 18	M18	2,50	27	18	4	10
	PLMS 20	M20	2,50	30	20	4	10
	PLMS 24	M24	3	36	24	4	10
	PLMS 30	M30	3,50	46	30	5	4
	PLMS 36	M36	4	55	36	6	1
	PLMS 42	M42	4,50	65	42	7	1
	PLMS 48	M48	5	75	48	8	1
	PLMS 56	M56	5,50	85	84	-	1
	PLMS 64	M64	6	95	96	-	1
	PLMS 72	M72	6	105	108	-	1
	PLMS 80	M80	6	115	120	-	1
	PLMS 90	M90	6	130	135	-	1
PLMS 100	M100	6	145	150	-	1	

pewag PLGS screw for PLGW

This screw is one of the spare parts for the PLGW pewag profilift gamma lifting point with a metric thread.



PLGS Screw for PLGW	Code	Thread [mm]	VPE [Unit]
	PLGS 0,3 t	M8	10
	PLGS 0,5 t	M10	10
	PLGS 0,7 t	M12	10
	PLGS 1,5 t	M16	10
	PLGS 2,3 t	M20	10
	PLGS 3,2 t	M24	10
	PLGS 4,9 t	M30	4
	PLGS 7 t	M36	1
	PLGS 9 t	M42	1
	PLGS 12 t	M48	1

pewag PLGES spare latches set

The spare latches set for the PLGW pewag profilift gamma supreme is available now.

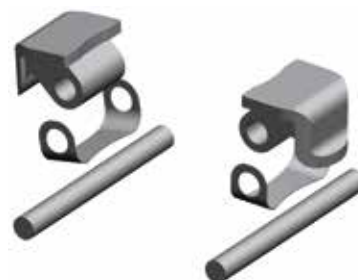

PLGES Spare latches



Code	Accessory part for	VPE [pair]
PLGES 0,5 t	PLGW 0,3 t; PLGW 0,5 t; PLGW U 3/8	1
PLGES 0,7 t	PLGW 0,7 t; PLGW U 1/2	1
PLGES 1,5 t	PLGW 1,5 t; PLGW U 5/8	1
PLGES 2,3 t	PLGW 2,3 t; PLGW U 3/4	1
PLGES 3,2 t	PLGW 3,2 t; PLGW U 1	1
PLGES 4 t	PLGW 4 t; PLGW 4,9 t; PLGW U 1 1/4	1
PLGES 7 t	PLGW 7 t; PLGW U 1 1/2	1
PLGES 9 t	PLGW 9 t; PLGW U 1 3/4	1
PLGES 12 t	PLGW 12 t	1

pewag PLAS screw for PLAW

pewag spare parts are guaranteed to pass any quality test - and the PLAS screw for the PLAW pewag profilift alpha with metric thread is no exception. Suitable for the PLAW type with sleeve.



PLAS screw for PLAW



Code	Thread [mm]	VPE [Unit]
PLAS 0,3 t	M8	10
PLAS 0,63 t	M10	10
PLAS 1 t	M12	10
PLAS 1,5 t	M16	10
PLAS 2,5 t	M20	10
PLAS 4 t /13 ¹⁾	M24	10
PLAS 6 t	M30	4
PLAS 8 t	M36	1
PLAS 10 t	M42	1
PLAS 15 t	M42	1
PLAS 20 t	M48	1

¹⁾ Only available for new model version

pewag PLBS screw for PLBW

This screw is one of the parts for the PLBW pewag profilift beta lifting point with a metric thread.



PLBS Screw for PLBW	Code	Thread [mm]	VPE [Unit]
	PLBS 0,3 t	M8	10
	PLBS 0,6 t	M10	10
	PLBS 1 t	M12	10
	PLBS 1,3 t	M14	10
	PLBS 1,6 t	M16	10
	PLBS 2 t	M18	10
	PLBS 2,5 t	M20	10
	PLBS 3 t	M22	10
	PLBS 4 t	M24	10
	PLBS 5 t	M27	4
	PLBS 6,3 t	M30	4
	PLBS 8 t	M33	2
	PLBS 10 t	M36	1
	PLBS 12,5 t	M42	1
	PLBS 15 t	M48	1

pewag SFGW-A safety catch sets

These SFGW-A safety catch sets forged-with and electro-galvanised safety catch and a spring made from rust-proof spring steel are all about safety and security.

The safety catch sets are in a league of their own - even the tiniest pewag parts offer outstanding quality!



SFGW-A safety catch sets Code	Code	For accessory part
	SFGW-A 1	AWHW 1,3
	SFGW-A 3	AWHW 3,8
	SFGW-A 6	AWHW 6,3, AWHW 10

pewag PLGIS Allen key set

Assembly of the PLGW requires tools. Special Allen keys make assembly of the PLGW basic M8 up to and including M20 particularly straightforward. The keys are marked with the size and the torque and are available as a complete set.

The PLGW supreme is designed for tool-free assembly.



pewag ALP thread adapter

Loads often come with tapped holes for DIN-580 eyebolts.

The thread adapter can be mounted using a commercial open-jawed spanner; the pewag lifting point is then mounted according to the instruction manual.

By using the pewag thread adapter, the high-strength pewag lifting points (PLAW, PLBW, PLGW, PLDW) can replace the standard eyebolts.

The thread adapter can be mounted using a commercial open-jawed spanner; the pewag lifting point is then mounted according to the instruction manual. The permitted working load limit corresponds to the pewag lifting point fitted in the internal thread.



pewag peTAG chip

The pewag peTAG solution enables the intelligent, location-independent management of product-specific information.

Via an NFC chip on the product, relevant product information (working load limits, safety instructions, operating manual) is literally at your fingertips. All you need is a NFC-compatible smartphone.

Your benefits at a glance:

- Clear object identification.
- Efficient documentation of test processes.
- Safe archiving of data.
- Mobile data retrieval without expensive readers.
- Automated compilation and dispatch of inspection reports.
- Efficient interaction with service partners.
- Intelligent, high-performance online platform.

Note: As every lifting point comes with just one pilot hole, you can use them either for the peTAG (NFC chip) or the PIP (colour marking).



Example: PLGW with peTAG (NF chip)



peTAG solution:
Smart solution
– intelligent core

pewag PIP colour marking

The PIP is a variable marking made from soft plastic that fits into the existing 4mm peTAG hole on all screw-in pewag winner lifting points.

The plug is a visual indicator for regular inspections – if no peTAG was fitted into the hole, the PIP may be fitted instead, serving as a test marking.

It is characteristic of the PIP that it is available in a different colour each year. The user (and tester) is thus able to determine the date of the latest inspection based on the colour of the PIP.

Note: As every lifting point comes with just one pilot hole, you can use them either for the peTAG (NFC chip) or the PIP (colour marking).

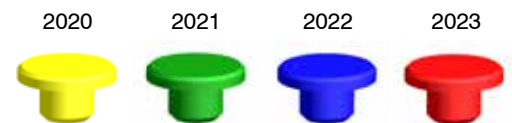

Hardened shell –
intelligent core

peTAG solution

A pewag solution that packs a punch.



Interested?
peTAG@pewag.com

User information

for lifting points

User information

User information

78-79





User information

Information and safety guidelines on usage, storage, inspection and servicing of pewag winner lifting points.

General information

pewag winner profilift lifting points are quality products that are suitable for a wide range of general lifting purposes using different designs, types of load and application modes. For detailed information on design types and the classification of working load limits, please refer to the tables in this catalogue

Responsibility is key

If the pewag winner profilift lifting points are used correctly and by competent persons, they have a long lifespan and provide the highest possible safety standards. Material and personal damage can be avoided by reading this user information carefully and handling all lifting processes in a responsible, provident manner.

Please note that all operating manuals that come with the product must be complied with at all times!

Changes to the condition as delivered

Only the original parts provided in the delivery may be used to complete the installation.

Modifying the original condition by grinding, welding (with the exception of the weldable lifting points), drilling, stamping etc. is not permitted and means exposing yourself and others to unnecessary danger. In such a case, safety can no longer be guaranteed and usage becomes dangerous. pewag does not accept any liability in such cases. Do not apply any surface coatings, i.e. do not subject them to hot galvanizing or electrogalvanizing. Cleaning processes that rely on dipping or removing a coating with chemicals are potentially dangerous processes that may give rise to hazards.

We recommend consulting pewag prior to performing these processes. The welding seam of the weldable lifting points are best protected against corrosion by applying a varnish.

Correct usage of the lifting points

If used correctly, pewag winner profilift lifting points are safe and strong. Please note that they may only be used by authorised personnel who have received sufficient training. Correct usage is subject to the following principles: The position on the load must be chosen in such a way that the transmitted forces of the base material can be absorbed without any deformations. Prior to loading, the load bracket needs to be adjusted in the direction of pull. Non-permissible

strains such as twisting or rotating the load must be avoided. Please ensure that the lifting gear can be mounted and demounted without any risk of injury! Damages to the load, lifting gear or lifting can be avoided by proper positioning. In cases where a single lifting point is used, this has to be mounted flat over the centre of gravity of the load. When using two lifting points (2-leg chain sling), these have to be mounted symmetrically on both sides of the centre of gravity of the load. When using 3 or 4 lifting points (3 or 4-leg chain slings), these have to be mounted evenly on one level surrounding the centre of gravity of the load. Care must be taken to ensure that the load is evenly spread among the individual chain legs.

In case of asymmetrical load distribution, the working load limit must be reduced in accordance with the working load limit table supplied. This may result in you having to use a lifting point of the next highest working load limit. Usage in acids and caustic solutions or exposure to their vapours is not permitted. Please be aware of this requirement at all times as certain production processes release acids and/or vapours! The working load limit will also be reduced if the lifting points are exposed to higher temperatures. Please comply with the supplied operating instructions at all times. For further information, please contact the pewag technical service team.

Screw-in lifting points

We recommend the following minimum screw penetration:

- 1 x M for steel (M = thread size, for instance M16)
- 1.25 x M for cast steel
- 2 x M for aluminium

To ensure safe usage, the thread size and thread length for materials of lower strength, like light metals, non-ferrous metals or cast iron, must be chosen in such a way that the occurring loads may be absorbed by the lifting point.

Impact loading or vibration may cause the screw to become loose. To avoid this, apply a liquid threadlock such as Loctite. If using additional tools of this sort, please follow the manufacturer's instructions. pewag accepts no liability if components are used that are not part of the pewag range (e.g. screws).

Please check the following points prior to each usage:

- Screws are sufficiently tightened and the fastening torque corresponds to that specified in the operating manual
- The lifting point is complete, i.e. no components are missing
- The stamp of the lifting point is clearly legible
- The lifting point shows no signs of damage such as notches, cracks, deformations, wear, strong corrosion, surface cracks on load-bearing parts, noticeable signs of excessive heat exposure (such as burnt varnish, discolouration of the base material)
- Rotatable lifting points may be rotated freely and smoothly.

In addition, check before each assembly:

- Screws and threads are not damaged
- Correct screw size, screw grade and screw depth

The supplied operating manual must be complied with at all times!

If in doubt or in case of visible damage, the lifting points must be decommissioned and inspected by a competent person. This also applies to usage after unusual events, for instance uncontrolled exposure to heat.

Weldable lifting points

For welding, the following instructions apply:

- Welding processes may only be performed by a qualified welder according to EN ISO 9606-1.
- The material of the welded-on parts is specified on the operating manual that is included in the scope of delivery.
- The surface of the welding area must be thoroughly cleaned before welding. Rust and scale, paint, oil or similar must be removed.
- Contact between the coated bracket and the welded material must be avoided

Please check the following points prior to each usage:

- The stamp of the lifting point is clearly legible
- The lifting point shows no signs of damage such as notches, cracks, deformations, wear, strong corrosion, surface cracks on load-bearing parts, noticeable signs of excessive heat exposure on the coated bracket (such as burnt varnish, discolouration of the base material)
- No surface cracks or damage along the welding seam

The supplied operating manual must be complied with at all times!

If in doubt or in case of visible damage, the lifting points must be decommissioned and inspected by a competent person. This also applies to usage after unusual events, for instance uncontrolled exposure to heat.

Correct maintenance

The maintenance of pewag winner profilift lifting points must be performed by competent persons. Improper use or use by unauthorised persons must be avoided at all times.

Prevention is better than cure!!

Prior to using a lifting point, it must be verified whether the lifting point was inspected every 12 months by a competent person and in accordance with applicable national standards. If the chain sling is frequently used at its full working load limit, more frequent inspections are required! All inspections must be documented, in particular with regard to results and servicing activities. These records must be kept throughout the service life of the lifting points.

A sample documentation sheet is available for download at www.pewag.com.

Clean storage

pewag winner profilift lifting points must always be stored in a clean and dry conditions and protected against corrosion, i.e. slightly lubricated.

The thread shafts must be protected from damage using appropriate means.

Important

With the exception of the RGS eyebolt, all pewag winner profilift lifting points may also be used as lashing points. The admissible lashing capacity is double the nominal working load limit, as a 2-fold safety factor applies to the securing of loads. For the PLBW lifting points, a 2.5-fold safety factor applies as lifting operations require a safety factor of 5:1 for lifting operations. We recommend consulting the pewag technical service prior to using the lifting points as lashing points.

Example

PLE/N 8 = 2,000 kg working load limit for lifting operations. As lashing point LC = 4,000 daN admissible lashing capacity

Please refer to our website at www.pewag.com for detailed information on working load limits, measures and 3D models (section Lifting Technology / Lifting Points). Each lifting point comes with a detailed operating manual in two languages.

Detailed original operating manuals for all our pewag quality products are available for download at www.pewag.com. Our manuals are subject to a continuous improvement process to ensure that they are always up to date. For this reason, always refer to the latest version of a manual.



pewag profilift lifting points
As individual as your needs.



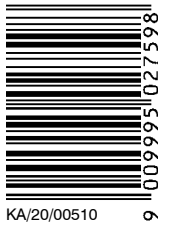

KA/20/00510 9



www.pewag.com



Follow us on LinkedIn

pewag austria GmbH

A-8041 Graz, Gaslaternenweg 4, Phone: +43 (0) 50 50 11-0, Fax: +43 (0) 50 50 11-100,
saleinfo@pewag.com, www.pewag.com

